**HIGH PERFORMANCE ADJUSTABLE SPEED DRIVE
QUIET ASD SERIES**

TOSHIBA



**VARIABLE TORQUE
ADJUSTABLE SPEED DRIVE**

LONWORKS[®] COMMUNICATIONS INTERFACE

Introduction

Thank you for purchasing the “Echelon® LONWORKS Communications Interface” for the Toshiba E3 Quiet Transistor Adjustable Speed Drive (ASD). This communications interface allows the E3 ASD to connect directly to 78kbps free-topology and link-power twisted-pair networks that communicate via the Echelon LonTalk® protocol. Before using the LONWORKS interface, please be sure to thoroughly read the instructions and precautions contained in this manual. In addition, please make sure that this instruction manual is delivered to the end user of the drive unit into which the communications interface is installed, and keep this instruction manual in a safe place for future reference or drive inspection.

This instruction manual describes the device specifications, installation and wiring methods, maintenance procedures, functional profile, and network variable interface methods for the E3 LONWORKS communications interface.

Please note that this communications interface can also be used in other Toshiba 3-series adjustable speed drives, such as the G3. Not all functions may be accessible, however, in other units. These exceptions will be noted where applicable. Also, use of this interface in other Toshiba 3-series drives may require the use of an additional plug-in communications option ROM. For more information regarding the required combinations of adjustable speed drives, interface boards and option ROMs, please contact Toshiba International Corporation or your local distributor.

Usage Precautions

Operating Environment

- Please use the interface only when the ambient temperature of the drive unit into which the interface is installed is within the following specified temperature limits:

Operation: -10 ~ +40°C (+14 ~ +104°F)

Storage: -25 ~ +65°C (-13 ~ +149°F)

- Avoid installation locations that may be subjected to large shocks or vibrations.
- Avoid installation locations that may be subjected to rapid changes in temperature or humidity.

Installation · Wiring

- Do not touch charged parts such as the terminal block while the drive's CHARGE lamp is lit. A charge will still be present in the drive unit's internal electrolytic capacitors, and therefore touching these areas may result in an electrical shock. Always turn all drive input power supplies OFF, and wait at least 5 minutes after the CHARGE lamp has gone out before connecting communication cables or motor wiring.
- When installing the interface board into the drive and making wiring connections, make certain that no clippings or wiring leads that could cause device failure fall into the drive or onto electronic components.
- Proper ground connections are vital for both safety and signal reliability reasons. For proper grounding procedures, please refer to the section in this manual pertaining to grounding (section 3).
- Route the communication cables separate from the drive's input/output power wiring.
- To avoid the possibility of electric shock due to leakage currents, always ground the drive unit's E/GND terminal and the motor. To avoid misoperation, do not connect any communication cable shields to either of the above-mentioned grounds or any other power ground.

Other Precautions

- The drive's EEPROM has a life span of 10,000 write cycles. Do not write to the same parameter register more than 10,000 times.
- Do not touch or insert a rod or any other item into the drive while power is applied, as this may lead to electrical shock or drive damage.
- Commission the disposal of the interface board to a specialist.
- When the drive's control power supply is turned on, the E3 performs initialization functions for approximately 2 seconds, during which communications capabilities are disabled. Communications capabilities will also be disabled for approximately 2 seconds after momentary control power supply outages or drive resets.

TABLE OF CONTENTS

1.	Interface Board Diagram	5
2.	Interface Board Installation / Removal.....	6
2.1	Installation Procedure	6
2.2	Removal Procedure	9
3.	Grounding.....	11
4.	Equipment Specifications	13
5.	Maintenance And Inspection.....	14
6.	Storage And Warranty	15
6.1	Storage.....	15
6.2	Warranty.....	15
7.	LONWORKS Interface Configuration.....	16
7.1	LONWORKS Network Connections.....	16
7.2	Hardware Configuration.....	16
8.	Drive Parameter Settings	17
9.	Feature Summary.....	18
10.	Functional Interface.....	20
11.	Node Object.....	21
11.1	Object Overview.....	21
11.2	SNVT Details.....	21
11.2.1	<i>Input Network Variable</i>	<i>21</i>
11.2.2	<i>Output Network Variable.....</i>	<i>22</i>
12.	VSD Functional Profile Object	23
12.1	Object Overview.....	23
12.2	SNVT and SCPT Details	24
12.2.1	<i>Input Network Variables.....</i>	<i>24</i>
12.2.2	<i>Output Network Variables.....</i>	<i>24</i>
12.2.3	<i>Configuration Parameters.....</i>	<i>25</i>
13.	Toshiba-Specific Controller Object	28
13.1	Overview.....	29
13.2	SNVT and UNVT Details	30
13.2.1	<i>Input Network Variables.....</i>	<i>30</i>
13.2.2	<i>Output Network Variables.....</i>	<i>32</i>

13.3	Parameter Registers	34
13.3.1	<i>Read-Only Registers</i>	36
13.3.2	<i>FUNDAMENTAL PARAMETERS #1 (U_r.F)</i>	39
13.3.3	<i>FUNDAMENTAL PARAMETERS #2 (U_r.F2)</i>	40
13.3.4	<i>PANEL CONTROL PARAMETERS (U_r.Pn)</i>	40
13.3.5	<i>TERMINAL SELECTION PARAMETERS (U_r.St)</i>	41
13.3.6	<i>SPECIAL CONTROL PARAMETERS (U_r.SL)</i>	44
13.3.7	<i>FREQUENCY SETTING PARAMETERS (U_r.SF)</i>	45
13.3.8	<i>PROTECTION FUNCTION PARAMETERS (U_r.Pr)</i>	47
13.3.9	<i>PATTERN RUN CONTROL PARAMETERS (U_r.Pt)</i>	49
13.3.10	<i>FEEDBACK CONTROL PARAMETERS (U_r.Fb)</i>	51
13.3.11	<i>COMMUNICATION SETTING PARAMETERS (U_r.tr)</i>	52
13.3.12	<i>AM/FM ADJUSTMENT PARAMETERS (U_r.Rn)</i>	53
13.3.13	<i>UTILITY PARAMETERS (U_r.Ut)</i>	54
13.3.14	<i>MOTOR RATING PARAMETERS (U_r.Rt)</i>	56
13.4	Drive Typeform Codes	57
13.5	Drive Fault Codes	58
14.	LonManager Support Files	59
15.	Notes	60

1. Interface Board Diagram

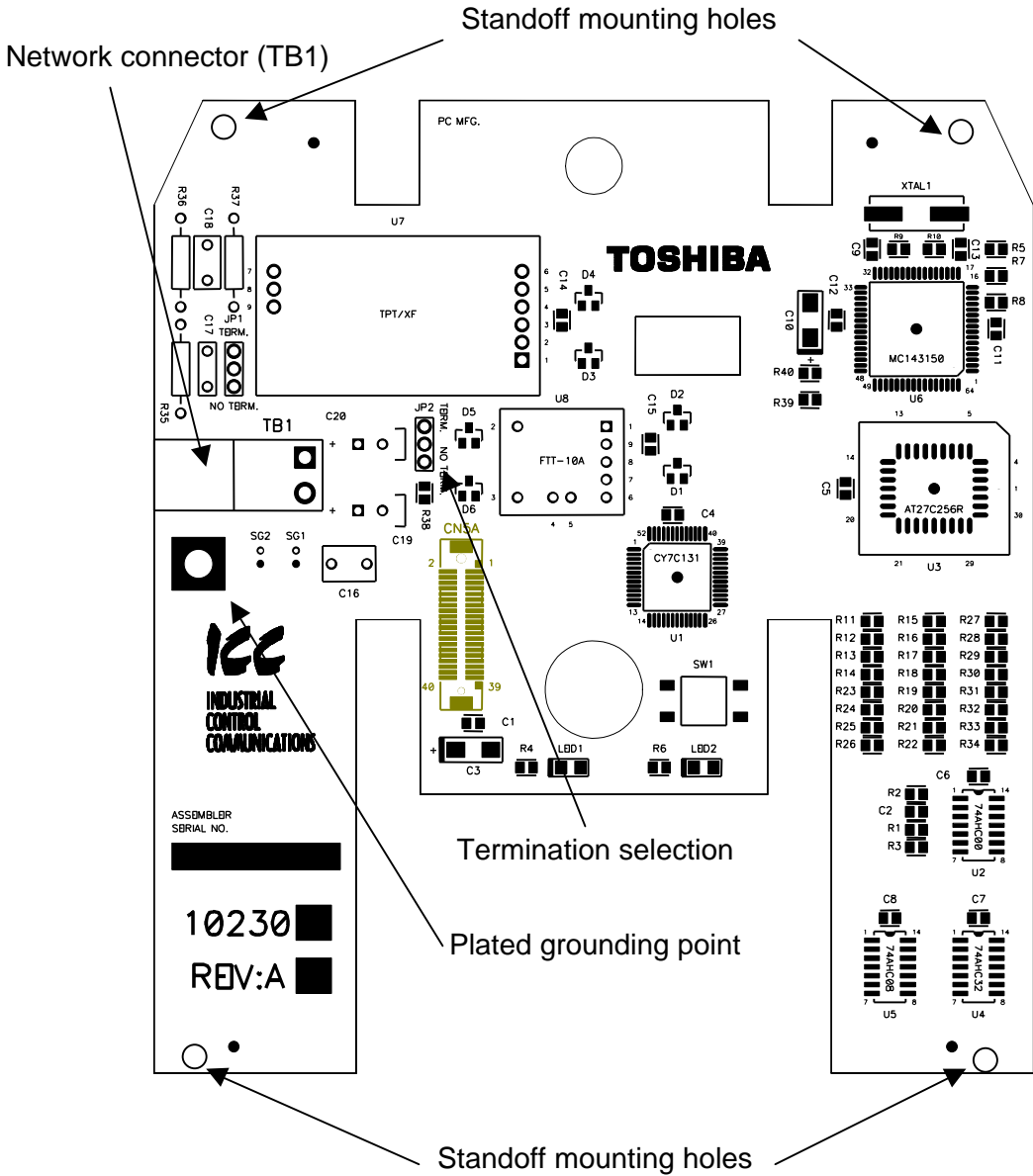





2. Interface Board Installation / Removal

The E3 adjustable speed drive does not require any additional hardware components other than the LONWORKS communications interface board in order to connect to and communicate with the LONWORKS network. This portion of the manual will detail the procedure used to install and remove the interface board. If at any time you experience problems during the installation / removal process, please contact Toshiba International Corporation for assistance.

2.1 Installation Procedure

Installation of the LONWORKS interface board into an E3 adjustable speed drive should only be performed by a qualified technician familiar with the maintenance and operation of the E3. To install the interface board, perform the following procedure:

1.  **CAUTION!** Verify that all input power sources to the drive have been turned OFF and are locked and tagged out.
2.  **DANGER!**  Wait at least 5 minutes for the drive's electrolytic capacitors to discharge before proceeding to the next step. **Do not touch any internal parts with power applied to the drive, or for at least 5 minutes after power to the drive has been removed. A hazard exists temporarily for electrical shock even if the source power has been removed.**
3.  Remove the drive's cover (open the door on units with hinged doors). Verify that the CHARGE LED has gone out before continuing the installation process.
4. Loosen the 4 screws attaching the E3's operation panel support bracket to the control board support bracket, and then remove the operation panel and support bracket as a unit (refer to Figure 1).
5. Install the 4 nylon standoffs into the holes provided in the control board support bracket (refer to Figure 2).
6. Install the LONWORKS network cable through the access holes at the bottom of the drive and route the cable in order to make connections to the interface board connector (TB1). Take care to not route the cable near any sharp edges or in positions where it may be pinched.

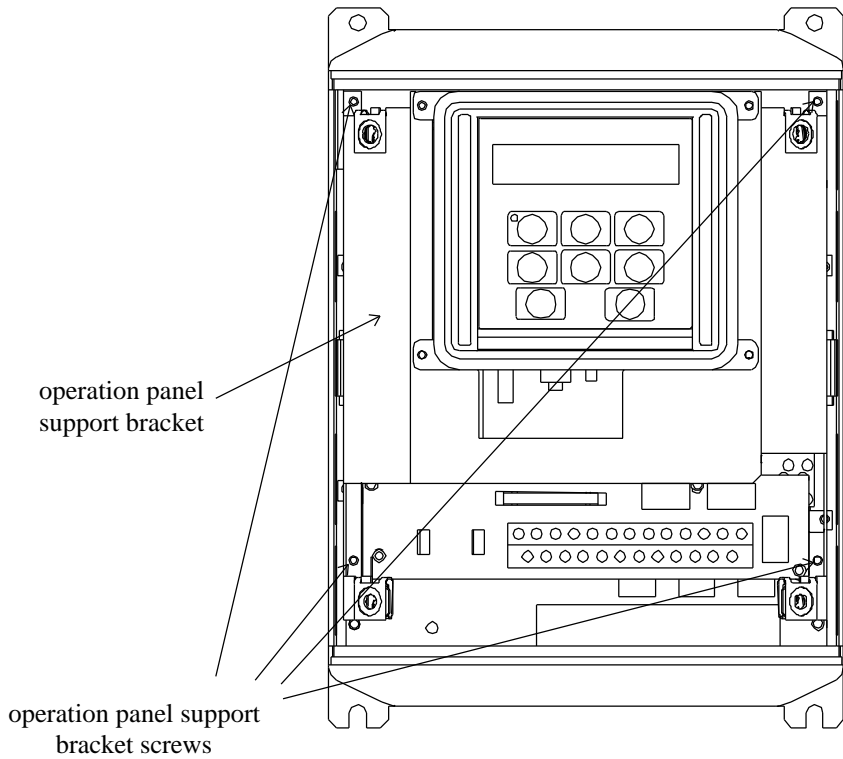

Figure 1: E3 with front cover removed

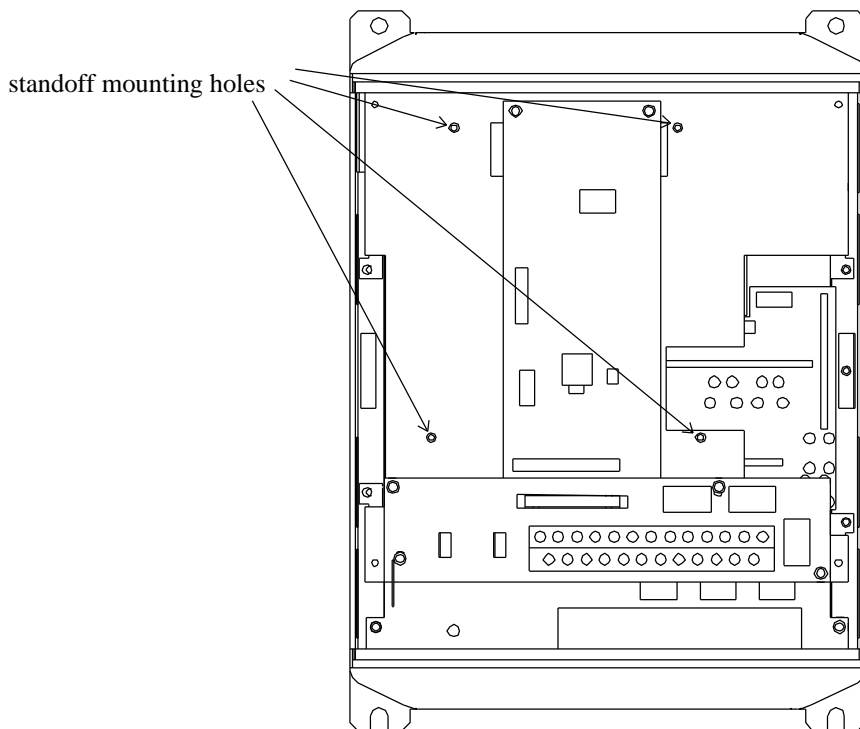



Figure 2: E3 with front cover and operation panel support bracket removed

7.  **CAUTION!** The LONWORKS interface board is a static-sensitive device. Standard electrostatic-sensitive component handling precautions should be observed. Connect the LONWORKS communication cable to the interface board connector (TB1). For more information on making connections to the LONWORKS communication network, refer to section 7 on page 16.

-  **CAUTION!** Extremely high voltages exist in the area near the interface board and connector (TB1) once installed in the E3. Ensure that no stray wires (such as network cable shields, etc.) come into contact with any internal drive components. Also ensure that the LONWORKS communication cable is not routed in such a manner that it may come into contact with high-voltage drive components, or drive components that may heat up during operation and damage the cable insulation.
8. Install the interface board into the drive by carefully aligning the 4 nylon standoffs with the 4 mounting holes provided in the interface board. Ensure that connector CN5A on the back side of the interface board is aligned with connector CN5 on the front side of the control board.
9. Press the interface board firmly onto the standoffs and connector CN5 until the standoff retaining tabs lock. Ensure that CN5 and CN5A are thoroughly interlocked.
10. Carefully re-install the operation panel and support bracket and tighten the 4 screws that attach the operation panel support bracket to the control board support bracket.
11. Reinstall the drive's cover (close and latch the door on units with hinged doors).





 **DANGER!**  **Do not operate the unit with the cover off / cabinet door open.**



12. Turn all power sources to the drive unit ON, and verify that the drive functions properly. If the drive does not appear to power up, or does not function properly, immediately turn power OFF. **Repeat steps 1 ~ 3 to remove all power from the drive.** Then, verify all connections. Contact Toshiba International Corporation for assistance if the problem persists.

2.2 Removal Procedure

Removal of the LONWORKS interface board from a E3 adjustable speed drive should only be performed by a qualified technician familiar with the maintenance and operation of the E3. In order to protect the interface board connector's reliability, do not repeatedly connect and disconnect the interface board. Use the following procedure if it becomes necessary to remove the LONWORKS interface board from the drive.

 **CAUTION!** Do not remove the interface board while power is applied to the drive. Removing the interface board with power applied may damage the drive.

1.  **CAUTION!** Verify that all input power sources to the drive have been turned OFF and are locked and tagged out.
2.  **DANGER!**  Wait at least 5 minutes for the drive's electrolytic capacitors to discharge before proceeding to step 3. **Do not touch any internal parts with power applied to the drive, or for at least 5 minutes after power to the drive has been removed. A hazard exists temporarily for electrical shock even if the source power has been removed.**
3.  Remove the drive's cover (open the door on units with hinged doors). Verify that the CHARGE LED has gone out before continuing the removal process.
4. Loosen the 4 screws attaching the operation panel support bracket to the control board support bracket and remove the operation panel and support bracket as a unit (refer to Figure 3).
5.  **CAUTION!** The LONWORKS interface board is a static-sensitive device. Standard electrostatic-sensitive component handling precautions should be observed. Release the 4 corners of the interface board from the standoffs by pressing down on the standoff locking tabs with a small flat-headed screwdriver. Be careful to not apply any abnormal stress to the interface board while performing this, as this may damage the interface board or control board connectors.
6. Remove the interface board from the drive.
7. Disconnect the LONWORKS communication cable from the interface board connector (TB1), and pull the cable out through the access holes at the bottom of the drive.
8. Carefully re-install the operation panel and support bracket and tighten the 4 screws that attach the operation panel support bracket to the control board support bracket.
9. Reinstall the drive's cover (close and latch the door on units with hinged doors).

 **DANGER!**  **Do not operate unit with the cover off / cabinet door open.**

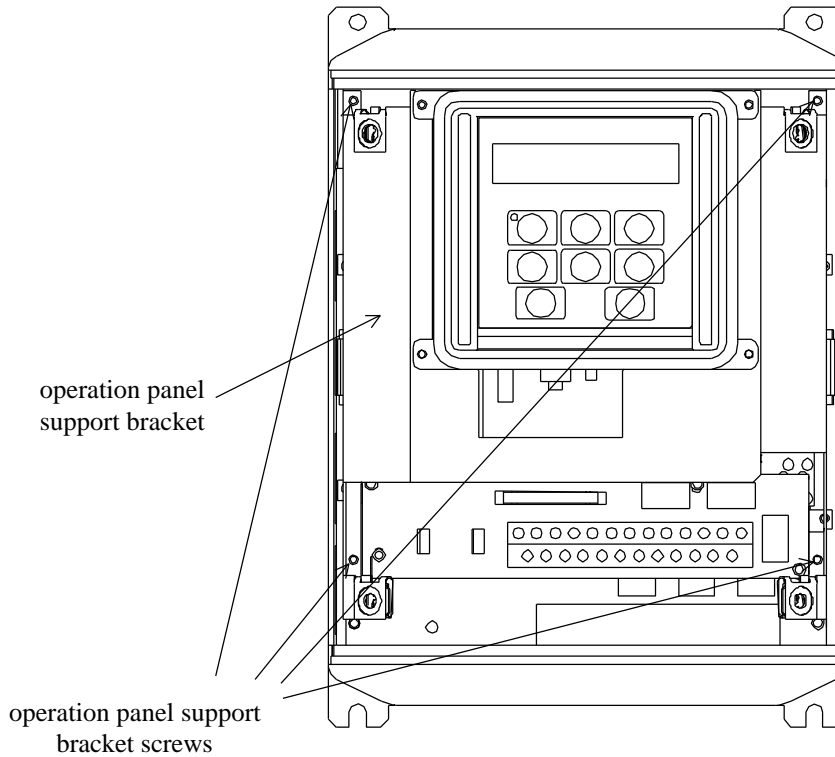

Figure 3: E3 with front cover removed

10. Turn all power sources to the drive unit ON, and verify that the drive functions properly. If the drive does not appear to power up, or does not function properly, immediately turn power OFF. **Repeat steps 1 ~ 3 to remove all power from the drive.** Then, verify all connections. Contact Toshiba International Corporation for assistance if the problem persists.

3. Grounding

Grounding is of particular importance for reliable, stable operation. Communication system characteristics may vary from system to system, depending on the system environment and grounding method used.

The E3 LONWORKS interface utilizes the Echelon FTT-10A 78kbps free-topology transceiver. The general schematic of the network interface portion of the E3 LONWORKS interface board is shown in Figure 4. This circuit has been tested by Echelon Corporation for ESD under both the preferred contact-discharge method and the alternate air-discharge method for electrostatic discharge (ESD), and exceeds level 4 in accordance with IEC 1000-4-2.

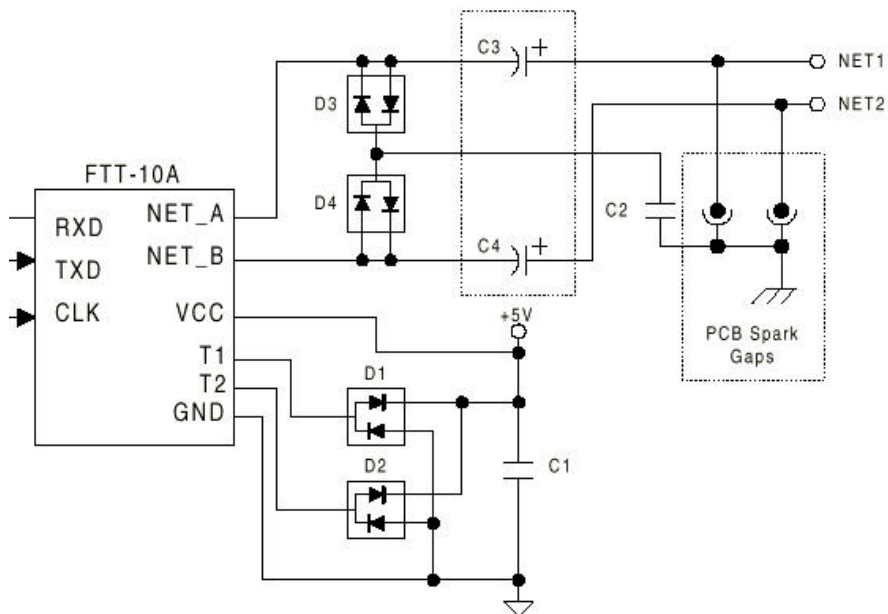

Figure 4: General Schematic of Network Interface

The LONWORKS interface board is provided with a plated ground connection point located near TB1, on the left-hand side of the board. This plated ground point is directly connected to the negative side of PCB spark gaps SG1 and SG2, shown in Figure 4. By connecting a wire with lug terminal to this grounding point, and then connecting the other end of the wire to an appropriate ground, a low-impedance circuit can be provided for bypassing high-voltage electrostatic discharges to earth ground. For specific details and requirements regarding protective grounding and installation of the LONWORKS network, refer to the appropriate Echelon LONWORKS system installation documentation.

Please be sure to consider the following points for making proper ground connections:

Grounding method checkpoints

1. Make all ground connections such that no ground current flows through the drive chassis.
2. Ensure that all grounds are connected to points that are at the same potential as drive grounds.
3. Do not connect the interface board's plated ground connection point to a power ground or any other potential noise-producing ground connection (such as the drive's E/GND terminal).
4. Do not make connections to unstable grounds (paint-coated screw heads, grounds that are subjected to inductive noise, etc.)

4. Equipment Specifications

Item	Specification
Operating Environment	Indoors, less than 1000m above sea level, do not expose to direct sunlight or corrosive / explosive gasses.
Operating Temperature	-10 ~ +40°C (+14 ~ +104°F)
Storage Temperature	-25°C ~ +65°C (-13 ~ +149°F)
Relative Humidity	20% ~ 90% (without condensation)
Vibration	5.9m/s ² {0.6G} or less (10 ~ 55Hz)
Grounding	Refer to the appropriate Echelon documentation
Cooling Method	Self-cooled

5. Maintenance And Inspection

Preventive maintenance and inspection is required to maintain the LONWORKS communication interface in its optimal condition, and to ensure a long operational lifetime. Depending on usage and operating conditions, perform a periodic inspection once every three to six months. Before starting inspections, always turn off all power supplies to the drive unit, and wait at least five minutes after the drive's "CHARGE" lamp has gone out.



DANGER!



Do not touch any internal parts with power applied to the drive, or for at least 5 minutes after power to the drive has been removed. A hazard exists temporarily for electrical shock even if the source power has been removed.

Inspection Points

- Check that the network terminal block screws are not loose. Tighten if necessary.
- Check that there are no defects in any attached grounding wire terminal crimp points. Visually check that the crimp points are not scarred by overheating.
- Visually check the wiring and cables for damage.
- Clean off any accumulated dust and dirt. Place special emphasis on cleaning the ventilation ports of the drive and all installed PCBs. Always keep these areas clean, as adherence of dust and dirt can cause premature component failure.
- If use of the drive is discontinued for extended periods of time, turn the power on at least once every two years and confirm that the unit still functions properly.
- Do not perform hi-pot tests on the drive or LONWORKS interface board, as they may damage the unit's internal components.

Please pay close attention to all periodic inspection points and maintain a good operating environment.

6. Storage And Warranty

6.1 Storage

Observe the following points when the LONWORKS interface board is not used immediately after purchase or when it is not used for an extended period of time.

- Avoid storing the interface board in places that are hot or humid, or that contain large quantities of dust or metallic dust. Store the interface board in a well-ventilated location.
- When not using the LONWORKS interface board for an extended period of time, apply power at least once every two years and confirm that it still functions properly.

6.2 Warranty

The LONWORKS communications interface kit is covered under warranty for a period of 12 months from the date of installation, but not to exceed 18 months from the date of shipment from the factory. For further warranty or service information, please contact Toshiba International Corporation.

7. LONWORKS Interface Configuration

7.1 LONWORKS Network Connections

The E3 LONWORKS interface board utilizes the Echelon FTT-10A 78kbps free-topology twisted-pair transceiver. The transceiver on the E3 interface board has been designed to be capacitively-coupled to the network, which also enables the interface board to be connected directly to link-power networks with no modification or configuration required. Each interface board is connected to the LONWORKS network by making communication cable connections to the terminals of connector TB1. For further LONWORKS network wiring requirements and procedures, please refer to the appropriate Echelon Corporation LONWORKS network installation documentation.

7.2 Hardware Configuration

Other than installing the interface board and connecting the LONWORKS network cable, the only other hardware configuration required is whether or not to terminate the network at each individual interface board. A jumper on the interface board (labeled "JP2") determines whether or not the LONWORKS network is terminated at the interface board (termination is a 52.3 Ω resistor). In a free topology segment, only one termination is required and may be placed anywhere on the segment. To terminate the segment at an interface board, set JP2 to "TERM". All other interface boards on the segment should have JP2 set to "NO TERM".

8. Drive Parameter Settings

LONWORKS interface communications are enabled by setting parameter `OPt` in `GrpE` to 2 (LONWORKS / Metasys / Tosline-F10). No other Tosline-F10 communication parameter settings apply when using the LONWORKS interface. When using any communication interface on the E3 ASD, the frequency command and command input received from the network can be enabled by setting parameters `FNOd` and `CNOd`, respectively, in `GrpE` to 3. For more information on methods for changing parameter settings, refer to the TOSHIBA [E3 Operation Manual](#).

The following is a list of the parameter settings that are required during setup to enable LONWORKS communications:

Parameter	Group	Required Value
<code>bLnd</code>	<code>GrpE</code>	1
<code>bLEr</code>	<code>GrpE</code>	1
<code>OPt</code>	<code>GrpE</code>	2

As is the same with all other communication configuration parameters, the drive must be reset after making the parameter changes described above in order for the changed settings to be enabled.

If the E3 drive into which a LONWORKS communication interface board is installed trips “`ErrE`” (communication interface card error) for any reason during initialization or operation, it is incapable of being reset via the network. When this trip condition occurs, therefore, the drive can only be reset locally via the panel or control terminal block.

If drive control (frequency command input, RUN/STOP, etc.) is to be performed via the LONWORKS network, the following drive parameters must also be set as shown:

Parameter	Group	Required Value
<code>CNOd</code>	<code>GrpE</code>	3
<code>FNOd</code>	<code>GrpE</code>	3

Of course, output network variables can always be monitored from the network regardless of the settings of `CNOd` (command mode selection) and `FNOd` (frequency mode selection). Also note that if the `CNOd` or `FNOd` parameters are changed while the drive is running, the change will not take effect until the next time the drive is stopped.

9. Feature Summary

The Toshiba E3 LONWORKS interface provides a wide array of network data access and drive control features. Combined with the flexible configuration capabilities of the LONWORKS network, powerful networked control and monitoring systems can be designed around the E3 drive. Some of the main features provided by the E3 LONWORKS interface are briefly described here:

Protocol

LonTalk protocol implemented via the Echelon 3150[®] Neuron IC.

Data Interface

Implements the LONMARK[®] Variable Speed Motor Drive Functional Profile, which provides network and functional interoperability. In addition, a Toshiba-specific LONMARK controller object is implemented, which provides access to all E3 parameters and operating variables. All data transfer is via Standard Network Variable Types (SNVTs), Standard Configuration Parameter Types (SCPTs), and 2 User Network Variable Types (UNVTs). For more information, refer to section 10 in this manual.

Network Support

Supports direct connection to both 78kbps free-topology and link-power networks.

Installation Methods

Switch SW1 on the interface board implements the SERVICE button function. LED1 (green) implements the network WINK function. Both of these features may be used to identify each drive during network installation.

Indicators

One green LED (LED1), which performs the following functions:

1. Flashes several times quickly upon drive power-up and after every reset to indicate that interface board initialization has been completed.
2. Flashes several times slowly when a network WINK command is received.
3. Remains ON continuously when a fatal error is detected. If this condition occurs during operation or upon initialization, check all interface board and drive control board connections. Contact Toshiba International Corporation for assistance if the problem persists or cannot be located.

One red LED (LED2), which implements the SERVICE indicator functions as specified in the Echelon Neuron IC databook.

Isolation

The network interface portion of the LONWORKS board is transformer-isolated from the remainder of the drive's control and power circuitry via the FTT-10A transceiver.

Network Connector

A 2-terminal connector provides polarity-insensitive connection to the LONWORKS network. In addition, a plated grounding point is provided for connection to a low-impedance earth ground for EMI level control.

10. Functional Interface

Three methods are implemented by the LONWORKS interface board to allow control and monitoring of the drive's data. First, the device's Node Object provides basic device information and control capabilities. Second, the interface implements the LONMARK Variable Speed Motor Drive Functional Profile. And lastly, a Toshiba-specific controller object is available, which allows access to data using different units and methods than the functional profile, as well as allowing access to all other internal drive configuration parameters and status data.

A conceptual representation of the E3 LONWORKS interface board, including inputs and outputs, is shown in Figure 5.

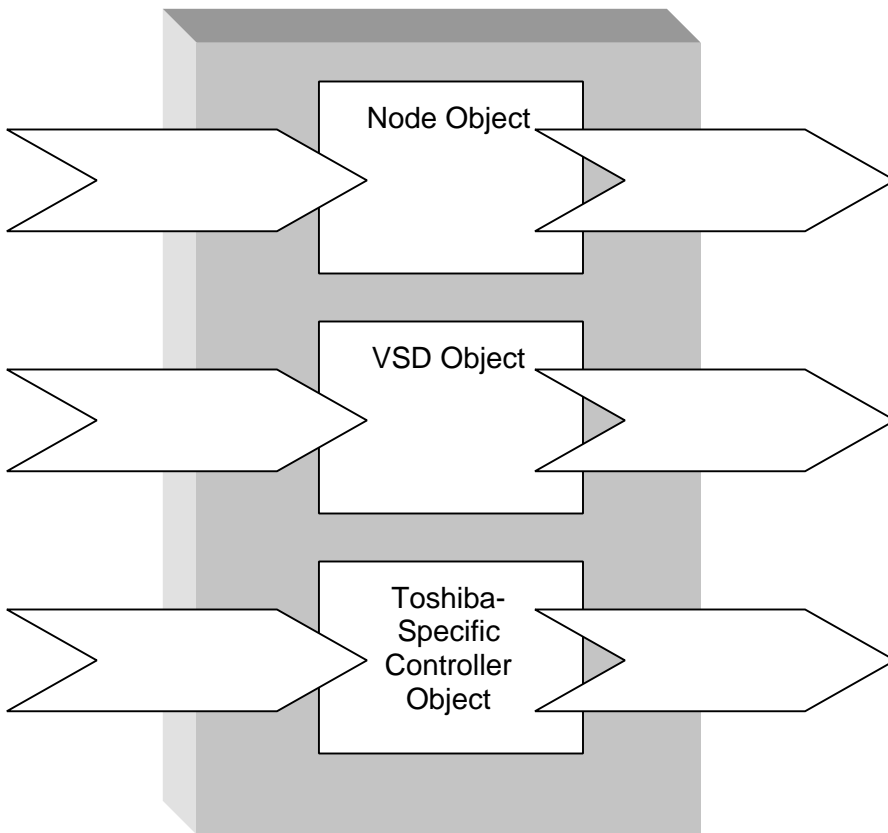

Figure 5: E3 LONWORKS Interface Conceptual Diagram

11. Node Object

11.1 Object Overview

The LONWORKS interface's Node Object provides general device information and allows some basic control and monitoring to be performed. A conceptual image of the E3 LONWORKS interface's Node Object is shown in Figure 6.

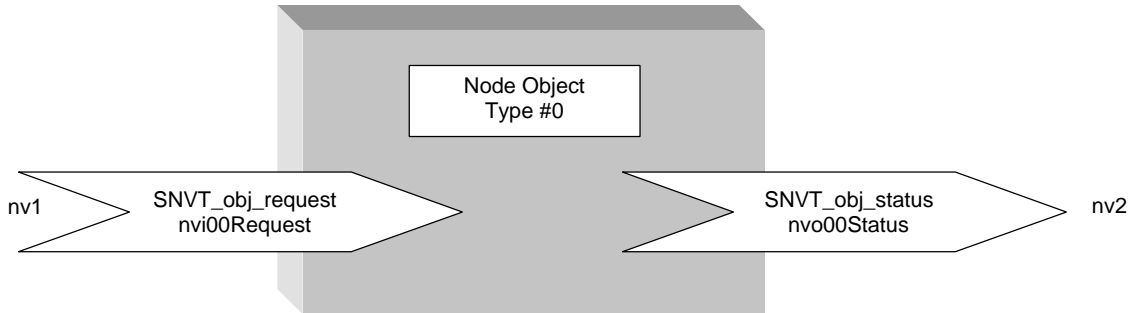

Figure 6: Node Object Details

11.2 SNVT Details

11.2.1 Input Network Variable

The input network variable, nvi00Request, contains 2 attributes which have the following properties:

<u>Attribute</u>	<u>Allowable Settings</u>
object_id.....	0 (node object), 1 (VSD object), 2 (Toshiba controller object)
object_request.....	RQ_NORMAL, RQ_ENABLE, RQ_UPDATE_STATUS, RQ_REPORT_MASK, RQ_DISABLED, RQ_CLEAR_ALARM

The object_id attribute may be set to 0,1 or 2 when accessing the node object. All of these values will access the same information and perform the same actions (i.e. the behavior of each of the 3 supported object types are not independent of each other with respect to the node object).

The allowable settings of the object_request attribute will generate the following actions:

<u>Setting</u>	<u>Action(s)</u>
RQ_NORMAL.....	Cancels a "disabled" state.
RQ_ENABLE.....	Cancels a "disabled" state.
RQ_UPDATE_STATUS	Generates an update of the output nvo00Status SNVT.

- RQ_REPORT_MASK.....Generates an update of the output nvo00Status SNVT, which each supported status attribute value set to TRUE (for self-documentation).
- RQ_DISABLEDIf the drive was running, the drive will stop. Further, all NVs that may cause the drive to run (such as nviDrvSpeedStpt, described later) will be disabled, preventing the drive from running.
- RQ_CLEAR_ALARM.....If the drive is faulted at the time this value is set, the drive will be reset. If the drive is not faulted when this value is set, no action will be taken and this setting will be ignored.

Note that any object_request sent with a valid object_id will generate an update of the output nvo00Status SNVT.

11.2.2 Output Network Variable

The input network variable, nvo00Status, contains 26 attributes of which 8 are supported. A summary of the supported attributes follows:

<u>Attribute</u>	<u>Possible Values</u>
object_id.....	Mirrors the setting of the nvi00Request object id (if valid).
invalid_id	Set to TRUE when the input object_id is set to an invalid value.
invalid_request	Set to TRUE when the input object_request is set to an invalid value.
disabled.....	Indicates whether the device is currently disabled
over_range.....	Indicates whether the data sent with the most recent configuration parameter update was greater than the drive's usable MAX range. If a configuration parameter data value sent to the drive is above that parameter's MAX limit, that data value will be ignored and this attribute will be set to TRUE.
under_range.....	Indicates whether the data sent with the most recent configuration parameter update was less than the drive's usable MIN range. If a configuration parameter data value sent to the drive is less than that parameter's MIN limit, that data value will be ignored and this attribute will be set to TRUE.
in_alarm	Indicates whether the drive is faulted.
report_mask.....	Indicates that this nvo00Status update is in response to a RQ_REPORT_MASK object request.

Again, the input object_id attribute may be set to 0,1 or 2, which will generate the corresponding output object_id. Regardless of the value, the same status information will be used to update the nvo00Status variable.

12. VSD Functional Profile Object

12.1 Object Overview

Figure 7 provides a general overview of the VSD object as implemented in the E3 interface board.

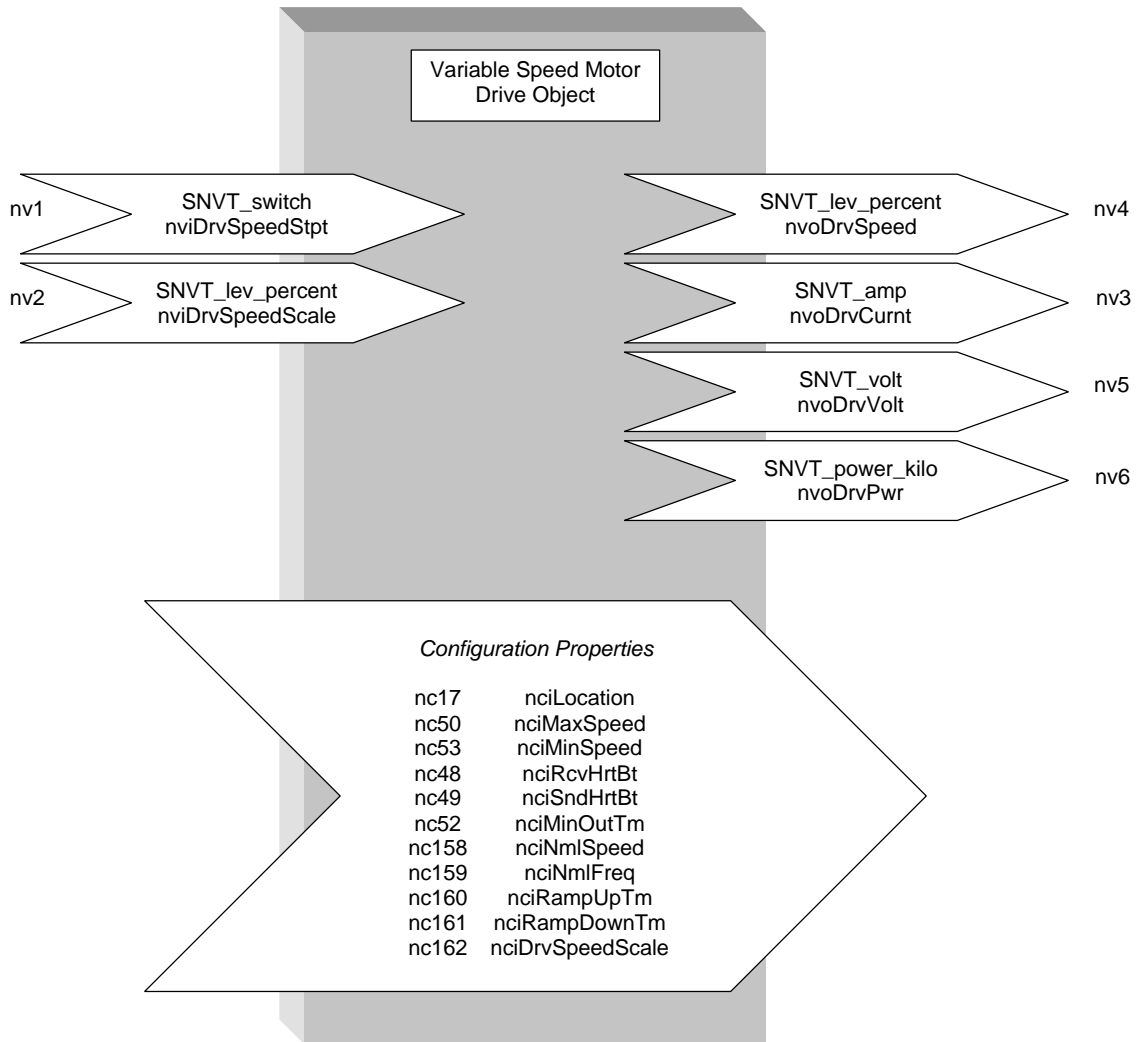

Figure 7: VSD Object Details

12.2 SNVT and SCPT Details

For detailed descriptions of each SNVT and SCPT included in the VSD Functional Profile, refer to the *LONMARK VSD Functional Profile*. This manual will briefly describe each SNVT and SCPT, and how they relate to interfacing with the E3 adjustable speed drive.

12.2.1 Input Network Variables

nviDrvSpeedStpt: This network variable controls both the drive's frequency command and run/stop command.

- **“State” attribute:** Default value is 0xFF (auto/invalid). If this value is 1, the drive will interpret this as a RUN command. If this value is any value other than 1, the drive will interpret this as a STOP command. Upon the occurrence of a receive heartbeat timeout, this value will return to its default value of 0xFF, causing the drive to stop if it was running.
- **“Value” attribute:** Default value is 0%. Range is 0-100%, with 100% meaning the value of parameter F_H (maximum output frequency) in Hz . For example, if the value of F_H is 80.00Hz, then 0-100% is interpreted by the E3 as a frequency command of 0-80.00Hz. F_H is continuously monitored by the interface board, and changes to this drive parameter will result in immediate rescaling of the 100% level for the “value” attribute. The “value” attribute is scaled by the value of `nviSpeedScale`, as detailed below and in the VSD functional profile.

Note that this network variable can be disabled and enabled by `RQ_DISABLED` and `RQ_ENABLE` object requests, respectively, sent to the node object (section 11.2).

nviDrvSpeedScale: Default value is 100%. Drive direction is determined by the sign of `nviDrvSpeedScale`, with positive values meaning run forward, and negative values meaning run reverse. For example, a value of 100% means run forward at `nviDrvSpeedStpt.value`, and a value of -75% means run reverse at 75% of `nviDrvSpeedStpt.value`.

12.2.2 Output Network Variables

nvoDrvSpeed: Indicates the current output frequency of the drive, with 100% meaning the value of parameter F_H (maximum output frequency) in Hz . Positive values indicate that the drive is operating in the forward direction, and negative values indicate that the drive is operating in the reverse direction.

nvoDrvCurrnt: Indicates drive output current in 0.1A units.

nvoDrvVolt: Indicates drive output voltage in 0.1V units.

nvoDrvPwr: Indicates drive output power in 0.1kW units. Because `SNVT_power_kilo` cannot be negative, negative output power readings (drive in regeneration mode) will be indicated as 0.0kW.

12.2.3 Configuration Parameters

When setting ranges are given in the following explanations, values received by the LONWORKS interface outside of those ranges will be ignored by the drive, and the last valid value received will continue to be used. Additionally, the node object's `over_range` and `under_range` `nvo00Status` attributes will always indicate whether or not the last configuration parameter update received was outside that parameter's valid setting range.

nciLocation: Not used by the E3 for any control purposes. The user may enter a 30-character or shorter string here for network reference.

nciMaxSpeed: Not used by the E3 for any control purposes. Included for interoperability only.

nciMinSpeed: Not used by the E3 for any control purposes. Included for interoperability only.

nciRcvHrtBt: Default value is 0 (disabled). If the receive heartbeat expires, the following 2 actions occur:

1. `nviDrvSpeedStpt.State = 0xFF` (drive will stop if it was running)
2. `nviDrvSpeedScale = nciDrvSpeedScale`.

For purposes of drive function, the definition of "heartbeat expires" is when both `nviDrvSpeedStpt` and `nviDrvSpeedScale` are not updated for a time exceeding the receive heartbeat time. Only one of these input variables needs to be updated to reset the receive heartbeat timer.

The receive heartbeat counter does not begin until the first time one of the above-mentioned input variables is updated after a drive power-up or reset procedure. Also, if the receive heartbeat setting is changed, that new value does not become effective until after the next update to either `nviDrvSpeedStpt` or `nviDrvSpeedScale`.

nciSndHrtBt: Default value is 0 (no automatic update). When the send heartbeat function is used, all output variables (including the Toshiba-specific controller object output variables described later) are automatically updated. If the send heartbeat function is not used, the drive's output variables will only be updated once one or more of them has changed significantly.

For purposes of drive function, the definition of "change significantly" is as follows:

- When output current changes by +/- 4% of rated drive current
- When drive feedback changes by +/- 4% of maximum output frequency
- When output voltage changes by +/- 4% of rated drive voltage
- When output power changes by +/- 4% of rated drive power

Even if only one of the above-mentioned output variables changes significantly, all output variables will be updated.

nciMinOutTm: Default value = 0.5s. If `nciMinOutTm > nciSendHrtBt`, and `nciSendHrtBt` is not 0, `nciSendHrtBt` will have priority, and `nciMinOutTm` will have no effect.

Figure 8 details the interaction between `nciMinOutTm` and `nciSndHrtBt`:

1. Previous output variable update occurred at point (1).
2. If an output variable first changes significantly in region (2), all output variables will be updated at point (3), at which time both the min out timer and send heartbeat timer will be reset.
3. If an output variable first changes significantly in region (4), all output variables will be immediately updated, and both the min out timer and send heartbeat timer will be reset.
4. If no output variables change significantly by the time point (5) is reached, all output variables will automatically be updated at point (5), and both the min out timer and send heartbeat timer will be reset.
5. If `nciMinOutTm` = 0, it has no effect in Figure 8, and output variables will be updated immediately whenever they change significantly or the send heartbeat timer expires.
6. If `nciSndHrtBt` = 0, region (4) in Figure 8 will continue indefinitely, and output variables will not be updated until at least one changes significantly.

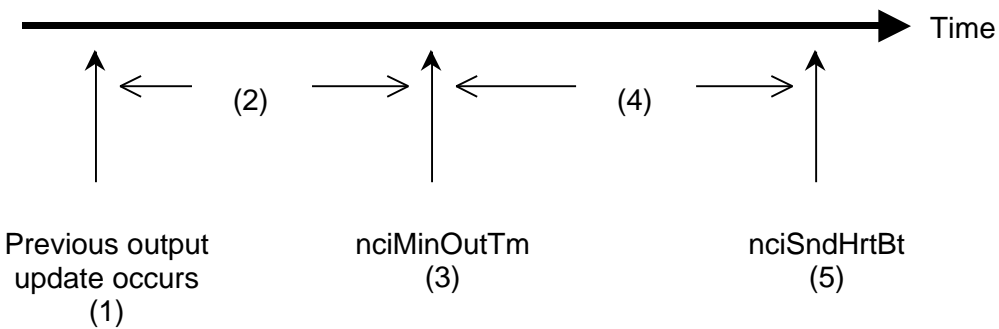

Figure 8: Behavior of `nciMinOutTm` and `nciSndHrtBt`

`nciNmISpeed`: Default value = 1710RPM. This configuration parameter maps to E3 parameter `ꠁꠁꠁ` (motor rated RPM) in `ꠁꠁꠁ`. Valid range is 0 ~ 9999RPM.

`nciNmIFreq`: Default value = 60Hz. This configuration parameter maps to E3 parameter `ꠁꠁꠁ` (motor rated frequency) in `ꠁꠁꠁ`. Valid range is 0 ~ 400Hz. Note that the drive's resolution of this parameter is 2Hz. Therefore, all values sent to the drive will be truncated to resolutions of 2Hz by the E3.

`nciRampUpTm`: Default value = 60s. This configuration parameter maps to E3 parameter `ꠁꠁꠁ` (acceleration time #1) in `ꠁꠁꠁ`. Minimum valid value is 0.1s, and maximum valid value depends on the setting of E3 parameter `ꠁꠁꠁ` in `ꠁꠁꠁ` (either 600.0s or 6000.0s).

`nciRampDownTm`: Default value = 60s. This configuration parameter maps to E3 parameter `ꠁꠁꠁ` (deceleration time #1) in `ꠁꠁꠁ`. Minimum valid value is 0.1s, and

TOSHIBA

maximum valid value depends on the setting of E3 parameter `dSPt` in `Cr.Ut` (either 600.0s or 6000.0s).

nciDrvSpeedScale: Default value = 100% (scale = 100%, direction = forward). This configuration parameter is used as the default value for SNVT `nviDrvSpeedScale`, and is only accessed on power-up, reset and receive heartbeat timeout.

13. Toshiba-Specific Controller Object

In addition to the LONMARK VSD Functional Profile outlined in section 11, the E3 LONWORKS interface provides an additional object for alternative and supplemental control and monitoring capabilities. This Toshiba-specific controller object can be used in addition to, or in place of, the VSD Functional Profile. While some of the SNVTs implemented in this additional object access the same data as the functional profile (frequency command vs. `nviDrvSpeedStpt.value`, for example), other SNVTs provide access to additional control and monitoring items not available when the functional profile alone is used (feedback enable/disable, for example). In addition, a Toshiba-defined input network variable and output network variable provide access to all E3 parameters, as well as all internal drive monitoring data.

Using this Toshiba-specific object is in no way mutually exclusive of using the LONMARK VSD Functional Profile. As both object's input network variables and output network variables are constantly processed, users may pick and choose which aspects of each implementation they wish to use. As certain input network variables access the same drive data in both the Toshiba-specific object and VSD Functional Profile object, however, only one of each of these variables should be bound under normal situations. These cases of "overlapping parameters" will be indicated in the detailed SNVT explanations in section 13.2.

13.1 Overview

Figure 9 shows a general overview of the Toshiba-Specific Controller Object.

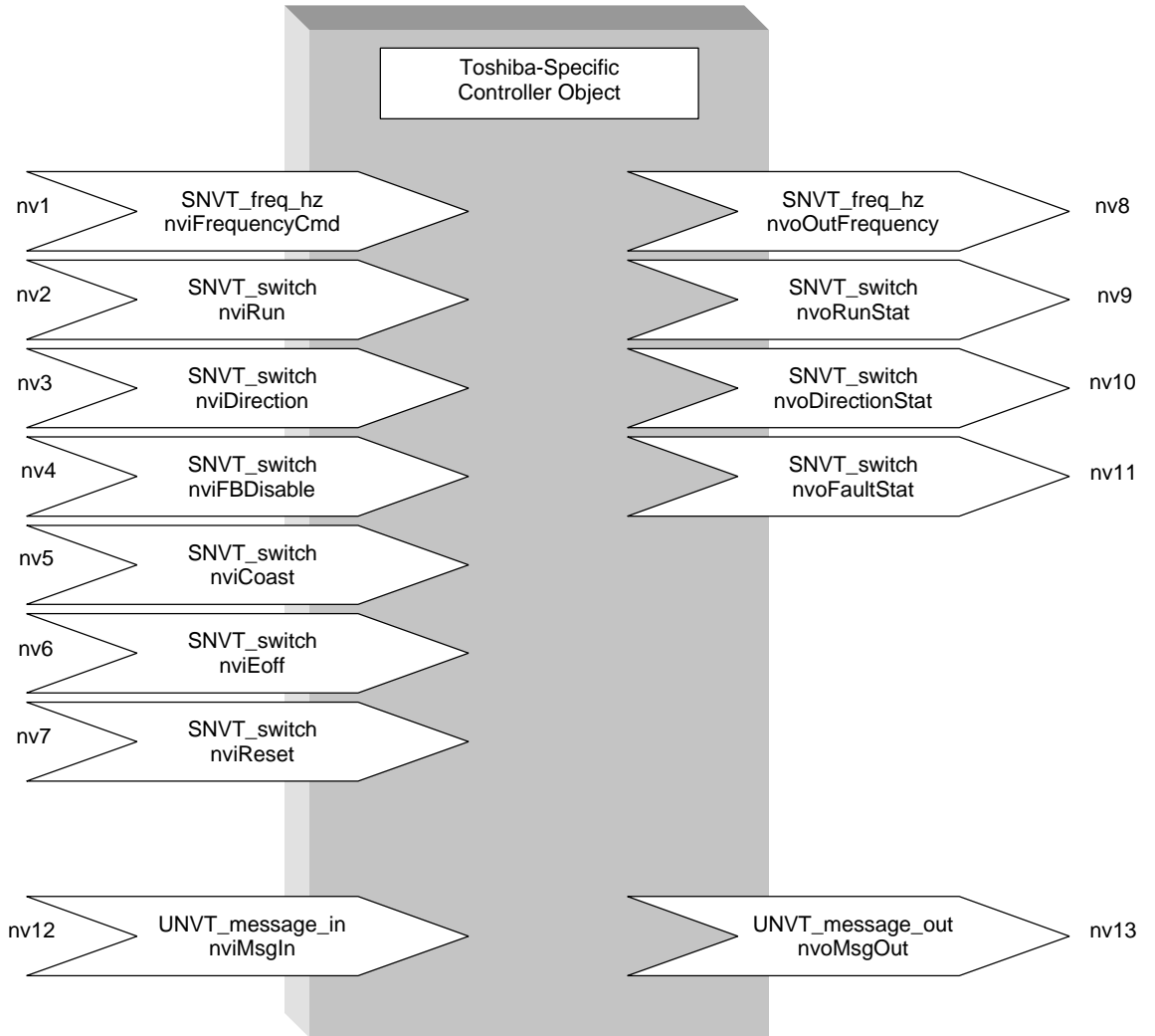

Figure 9: Toshiba Controller Object Diagram

13.2 SNVT and UNVT Details

13.2.1 Input Network Variables

nviFrequencyCmd: (nv1) SNVT_freq_hz. Drive's frequency command. Valid range is 0.0Hz ~ 400.0Hz. Regardless of the setting of this SNVT, the drive's actual output frequency will always be limited by the U_L and F_H parameters in $U_r.F$. This network variable controls the same drive parameter as nviDrvSpeedStpt.value. The receive heartbeat function also applies to this variable. Update of this variable therefore also resets the receive heartbeat timer.

nviRun: (nv2) SNVT_switch. Drive's RUN/STOP command. To send a RUN command to the drive, nviRun.state must be TRUE (1) and vniRun.value must be greater than 0. Any other combination will send a STOP command to the drive. This network variable controls the same drive parameter as nviDrvSpeedStpt.state. The receive heartbeat function also applies to this variable. Update of this variable therefore also resets the receive heartbeat timer.

Note that this network variable can be disabled and enabled by RQ_DISABLED and RQ_ENABLE object requests, respectively, sent to the node object (section 11.2).

nviDirection: (nv3) SNVT_switch. Drive's forward/reverse command. To send a FORWARD command to the drive, nviDirection.state must be TRUE (1) and vniDirection.value must be greater than 0. Any other combination will send a REVERSE command to the drive. This network variable controls the same drive parameter as the sign of nviDrvSpeedScale (“+” = forward and “-” = reverse). The receive heartbeat function also applies to this variable. Update of this variable therefore also resets the receive heartbeat timer.

nviFBDisable: (nv4) SNVT_switch. Enables/disables the drive's feedback (PID) control. To disable feedback control, nviFBDisable.state must be TRUE (1) and nviFBDisable.value must be greater than 0. Any other combination will enable feedback control. Note that enabling/disabling feedback control does not turn on/off feedback control. This input variable simply allows feedback control to be temporarily disabled when it has already been turned on (parameter $F_b.P$ in $U_r.F_b = 1$). The receive heartbeat function also applies to this variable. Update of this variable therefore also resets the receive heartbeat timer.

nviCoast: (nv5) SNVT_switch. Causes the drive to allow the motor to coast to a stop (free-run) by disabling all drive output transistors. To send a coast stop command, nviCoast.state must be TRUE (1) and nviCoast.value must be greater than 0. Any other combination will remove a coast stop command from the drive. The receive heartbeat function also applies to this variable. Update of this variable therefore also resets the receive heartbeat timer.

nviEoff: (nv6) SNVT_switch. Causes the drive to fault “E0FF” (emergency off). To send an emergency off command, nviEoff.state must be TRUE (1) and nviEoff.value must be greater than 0. Any other combination will not send an emergency off command to the drive. The receive heartbeat function also applies to this variable. Update of this variable therefore also resets the receive heartbeat timer.

nviReset: (nv7) SNVT_switch. Resets the drive when it is faulted. To send a reset command to the drive, nviReset.state must be TRUE (1) and nviReset.value must be

greater than 0. Any other combination will not send a reset command to the drive. Note that this variable will have no effect if the drive is not tripped. Also note that if this variable is set to “reset” when the drive is not tripped, and then the drive trips, the drive will reset immediately. Additionally, communication interface board (“E-IB”) faults cannot be reset via the network; they must be reset locally via the drive’s panel or terminal block. When a faulted drive resets, the LONWORKS interface board will also be reset, causing a momentary loss of communication to the drive (approximately 2 seconds). The receive heartbeat function also applies to this variable. Update of this variable therefore also resets the receive heartbeat timer.

nviMsgIn: (nv12) UNVT_message_in. This Toshiba-defined input network variable has the following construction:

```
typedef struct
{
    unsigned long MsgReg;
    unsigned long MsgDat;
    msg_action_type MsgAction;
} UNVT_message_in;
```

The enumerated type msg_action_type has the following definition:

```
typedef enum {r,R,w,W} msg_action_type;
```

To fully use the capabilities of this network variable, additional Device Resource Files (DRFs) are required by the LonManager DDE server. Refer to section 14 for information on how to obtain these files.

NviMsgIn allows read and write access to all drive operation, configuration and monitoring data via defined registers. To write data to a register, MsgReg is configured with the register number, MsgDat is configured with the data to write (in hexadecimal format), and MsgAction is configured with either ‘w’ or ‘W’. For example, to write a value of 70.00Hz to parameter FH in E-IB, MsgReg is set to 38, MsgDat is set to 0x1B58 (7000 in hexadecimal), and MsgAction is set to ‘w’ or ‘W’.

Similarly, to read from a register, MsgReg is configured with the register number and MsgAction is configured with either ‘r’ or ‘R’. MsgDat is ignored by the E3 LONWORKS interface during register read requests. The response data is then placed in output network variable nvoMsgOut (described in section 13.2.2).

Refer to section 13.3 for a complete list of available registers and the data values corresponding to them.

13.2.2 Output Network Variables

nvoOutFrequency: (nv8) SNVT_freq_hz. Drive's present operating frequency. Valid range is 0.0Hz ~ 400.0Hz. The send heartbeat and min out time functions also apply to this variable. This output variable is also updated when it "changes significantly" as previously described in section 12.2.3.

nvoRunStat: (nv9) SNVT_switch. Drive's RUN/STOP status. This output variable is only updated when all other output variables are updated. When the drive is running, attribute nvoRunStat.state is set to TRUE (1) and nvoRunStat.value is set to 100%. When the drive is stopped, attribute nvoRunStat.state is set to FALSE (0) and nvoRunStat.value is set to 0%.

nvoDirectionStat: (nv10) SNVT_switch. Drive's forward/reverse direction status. This output variable is only updated when all other output variables are updated. When the drive is operating in a forward direction, attribute nvoDirectionStat.state is set to TRUE (1) and nvoDirectionStat.value is set to 100%. When the drive is operating in a reverse direction, attribute nvoDirectionStat.state is set to FALSE (0) and nvoDirectionStat.value is set to 0%.

nvoFaultStat: (nv11) SNVT_switch. Drive's fault status. This output variable is only updated when all other output variables are updated. When the drive is faulted, attribute nvoFaultStat.state is set to TRUE (1) and nvoFaultStat.value is set to 100%. When the drive is not faulted, attribute nvoFaultStat.state is set to FALSE (0) and nvoFaultStat.value is set to 0%.

nvoMsgOut: (nv13) UNVT_message_out. This Toshiba-defined output network variable has the following construction:

```
typedef struct
{
    msg_status_type MsgStat;
    unsigned long MsgDat;
} UNVT_message_out;
```

The enumerated type msg_status_type has the following definition:

```
typedef enum {no_error, cannot_execute, data_error, invalid_register,
write_to_readonly, read_from_writeonly, invalid_command, other_error}
msg_status_type;
```

To fully use the capabilities of this network variable, additional Device Resource Files (DRFs) are required by the LonManager DDE server. Refer to section 14 for information on how to obtain these files.

Upon completion of a drive register read or write request (refer to network input variable nviMsgIn in section 13.2.1), MsgStat indicates the success or failure status.

If the read or write was successful, MsgStat will be updated with a value of no_error, and MsgDat will be updated with the value read (if a register read operation was requested) or with the value written (if a register write operation was requested). Note that the contents of MsgDat are always represented in hexadecimal format. For example, if parameter 0x1F in 0x1F (register 39) were read from, and 0x1F was set to 60.00Hz (data = 6000 decimal = 1770 in hexadecimal), then MsgDat would be set to 0x1770 upon successful completion of the read request.

If an error occurs during the processing of the read or write request, MsgDat will be set to a value of 0, and MsgStat will be updated with one of the following error codes:

<u>Error Code</u>	<u>Meaning</u>
cannot_execute.....	cannot execute (while drive was running, an attempt was made to write to a register than cannot be written to while the drive is running, etc.)
data_error.....	data error (written data value outside of valid range)
invalid_register.....	invalid register (requested register does not exist or is reserved)
write_to_readonly.....	an attempt was made to write to a read-only register
read_from_writeonly...	an attempt was made to read from a write-only register
invalid_command.....	invalid command error (command other than r, R, w or W).
other_error.....	other / unclassified error

Refer to section 13.3 for a complete list of available registers and the data values corresponding to them.

13.3 Parameter Registers

How To Use This Section:

This section contains tables which describe all of the parameter registers accessible from the LONWORKS network via the `nviMsgIn` and `nvoMsgOut` network variables. Refer to section 13.2 for more information. The descriptions for the columns in the listed tables are as follows:

Register..... The register number used to access the parameter.

Bit..... This column only applies to read-only registers (section 13.3.1). If the register is comprised of a collection of individual bit-oriented status items (for example, register 13), this column will indicate which bit(s) in the word-sized register the corresponding parameter described in the *Function* column uses (bit 0 = LSB, bit F = MSB). If the parameter uses the whole register, "word" will appear in this column, indicating the parameter consumes the entire register (this does not mean, however, that all register bits are used: refer to the explanation for *Mask* below). All read/write registers (starting with section 13.3.2) have word-size data. Other possible values in this column are "low byte" (bits 0 ~ 7) and "high byte" (bits 8 ~ F).

Title Indicates the LED panel display of the function accessed through this parameter register.

Bank..... 0 = RAM (volatile), 1 = EEPROM (nonvolatile), 0/1 = RAM & EEPROM, 2, 3 and 6 = code space (read-only). **IMPORTANT:** the drive's EEPROM has a life span of 10,000 write cycles. Do not write to a read/write parameter register whose bank is listed as 1 or 0/1 more than 10,000 times.

Mask The data bits within a register that are not covered by the hexadecimal mask (for example, bits 8 ~ F if the mask is 00FF) will always be returned as 0 during data reads and will be ignored during data writes. For example, if a hexadecimal value of AB98 is sent to a register whose mask is 00FF, the actual value written to the register's corresponding parameter will be 0098. As this is not considered an error, no exception response will be generated if this type of extraneous data condition occurs.

Adjustment Range... Indicates valid data settings in real terms (Hz, ON/OFF, etc.)

Multiplier..... Indicates scaling factor used to convert *Adjustment Range* data into integer values. The equation used for this conversion is:

$$\text{Actual Parameter Register Data} = \text{Real Data} \cdot \text{Multiplier}$$

For example, if 60.00Hz maximum output frequency (F_H in 0.01) were desired, register 38 must be set to [60.00 ÷ 0.01] = 6000 decimal (= 1770 hex).

Example Table Excerpt:

Register	Title	Bank	Mask	Adjustment Range	Multiplier
38	FH (*)	0 / 1	FFFF	0BB8 ~ 9C40 (30.00~400.00)	0.01
39	ULI	0 / 1	FFFF	09C4 ~ 9C40 (25.00~400.00)	0.01
40	ULSL (*)	0 / 1	0030	0000: Input voltage level (0) 0020: Automatic setting (1) 0030: Stationary setting (2)	—
41	ULUL	0 / 1	FFFF	0000 ~ 0258 (0 ~ 600)	1
42	DIR	0 / 1	0020	0000: Reverse allowed (0) 0020: Reverse not allowed (1)	—

Other Programming Register Notes:

- When requesting data, register numbers must be entered in decimal, but data must be written (and will be returned) in hexadecimal format (for example, 29 hex = 41 decimal). Occasionally, hexadecimal notation in this document may also take the form of a number beginning with “0x”.
- Reading from or writing to registers marked as "Reserved" will generate an “invalid_register” error.
- Certain parameter registers cannot be written to while the drive is running. These registers will be indicated by the character (*). If an attempt is made to write to these registers while the drive is running, a “cannot_execute” error will be generated.
- The parameter register data for all read/write registers with *Bank* information listed as 0/1 will be retrieved from bank 0 (RAM) during reads and will be written to both banks 0 and 1 (RAM and EEPROM) during writes.
- All parameters in `ULUL` (section 13.3.11) are retrieved by the drive from non-volatile memory upon drive initialization only. When any of these registers are modified, therefore, the drive must be reset for the changed values to take effect.
- If the command mode selection (`ULUL`) or frequency mode selection (`ULUL`) parameters are changed while the drive is running, the change will not take effect until the next time the drive is stopped.
- Registers which indicate “E3 only” are applicable only to the E3 ASD. When the LONWORKS interface is used on non-E3 ASDs, data read from these registers will have no meaning, and data should not be written to these registers, or unpredictable drive operation may occur.

13.3.1 Read-Only Registers

Register	Bit	Function	Bank	Mask	Adjustment Range	Multiplier
1 ~ 8	word	Reserved	—	—	—	—
9	word	IV terminal analog input value	0	FFFF	0000 ~ FFFF (0 ~ 100%)	100/65535
10	word	RX terminal analog input value	0	FFFF	0000 ~ 7FFF (-100% ~ 0%) 7FFF ~ FFFF (0% ~ 100%)	1
11	word	Frequency command monitor	0	FFFF	0000 ~ 9C40 (0.00 ~ 400.00 Hz)	0.01
12	word	Input voltage monitor(<i>Note 1</i>)	0	FFFF	0 ~ 255.0%	0.1
13	word	Output terminal status monitor	0	00FF	Refer to Table 1 (page 37)	—
14	word	Drive status 1	0	FFFF	Refer to Table 2 (page 37)	—
15	word	Drive status 2	0	00FF	Refer to Table 3 (page 38)	—
16	word	Present trip	0	007F	Refer to section 13.5 for fault codes	—
17	high byte	4th past trip (most recent)	0	7F00		—
	low byte	3rd past trip		007F		
18	high byte	2nd past trip	0	7F00		—
	low byte	1st past trip (oldest)		007F		
19	word	Pre-compensation output frequency	0	FFFF		0000 ~ 9C40 (0.00 ~ 400.00 Hz)
20	word	Post-compensation output frequency	0	FFFF	0000 ~ 9C40 (0.00 ~ 400.00 Hz)	0.01
21	word	Torque current monitor	0	FFFF	(<i>Note 2</i>)	0.01
22	word	Excitation current monitor	0	00FF	00 ~ FF (0 ~ 255%)	1
23	word	PID feedback value	0	FFFF	(<i>Note 2</i>)	0.02
24	word	Motor overload ratio	0	FFFF	0 ~ 65535 = 0 ~ 100%	100/65535
25	word	Drive overload ratio	0	FFFF	0 ~ 65535 = 0 ~ 100%	100/65535
26	word	DBR overload ratio	0	FFFF	0 ~ 65535 = 0 ~ 100%	100/65535
27	word	Input power (%)	0	FFFF	0000 ~ FFFF (0.0 ~ 6553.5)	0.1
28	word	Input power (kW)	0	FFFF	(<i>Note 3</i>)	—
29	word	Output power (%)	0	FFFF	(<i>Note 2</i>)	0.1
30	word	Output power (kW)	0	FFFF	(<i>Note 2, Note 3</i>)	—
31	word	RR terminal analog input value	0	FFFF	0000 ~ FFFF (0 ~ 100%)	100/65535
32	word	Input terminal status monitor	0	FFFF	Refer to Table 4 (page 38)	—
33	word	Input / output power units	0	0008	0000: 0.01kW 0008: 0.1kW	—
34	word	Command mode status	0	0003	0000: terminal 0001: panel 0002: option 0003: RS232C	—
35	word	Frequency mode selection status	0	000C	0000: terminal 0004: panel 0008: option 000C: RS232C	—
36	low byte	LONWORKS interface card software revision	—	—	—	—
	high byte	LONWORKS interface card software version				
37	word	Reserved	—	—	—	—

(Note 1) These monitor voltage units are not affected by the setting of parameter $d5P_u$ in $Gr.Ut$; they are always in units of %.

- (Note 2) These registers use signed data (data values larger than 7FFFH are negative). If the register data is 8000H or larger, the actual value can be obtained by: **actual value = - [FFFFH - (register data) + 1]**.
- (Note 3) If the input / output power units data is 0, the monitored data is in 0.01kW units, and the multiplier is 0.01. If the input / output power units data is 1, the monitored data is in 0.1kW units, and the multiplier is 0.1. The input / output power units value is automatically set according to the drive's capacity.

Table 1: Output Terminal Status Monitor (register 13)

	Bit	Output Terminal	0	1	Single-Bit Read Mask
Lower Byte	bit 0	unused (always 0)	—	—	—
	bit 1	unused (always 0)	—	—	—
	bit 2	FAN	OFF	ON	0004
	bit 3	FL	FLB-FLC shorted	FLA-FLC shorted	0008
	bit 4	MS relay	OFF	ON	0010
	bit 5	OUT (option)	OFF	ON	0020
	bit 6	RCH	OFF	ON	0040
	bit 7	LOW	OFF	ON	0080

Table 2: Drive Status 1 (register 14)

	Bit	Drive Status	0	1	Single-Bit Read Mask
Lower Byte	bit 0	running (accel/decel)	Not running	running	0001
	bit 1	unused (always 0)	—	—	—
	bit 2	forward / reverse	Reverse	forward	0004
	bit 3	accel/decel #1/#2	accel/decel #1	accel/decel #2	0008
	bit 4	for drive use	—	—	—
	bit 5	for drive use	—	—	—
	bit 6	for drive use	—	—	—
	bit 7	jog/normal mode	normal (accel/decel)	jog mode	0080

	Bit	Drive Status	0	1	Single-Bit Read Mask
Upper Byte	bit 0	feedback ON/OFF	Feedback inactive	feedback active	0001
	bit 1	DC injection braking	OFF	DC inj. braking active	0002
	bit 2	V/F #1/#2	V/F #1	V/F #2	0004
	bit 3	coasting	not coasting	coasting	0008
	bit 4	emergency off	not in emergency off	in emergency off	0010
	bit 5	for drive use	—	—	—
	bit 6	for drive use	—	—	—
	bit 7	for drive use	—	—	—

Table 3 : Drive Status 2 (register 15)

Upper Byte	Bit	Drive Status	0	1	Single-Bit Read Mask
	bit 0	accelerating	not accelerating	accelerating	0001
	bit 1	decelerating	not decelerating	decelerating	0002
	bit 2	for drive use	—	—	—
	bit 3	retry	not retrying	retrying	0008
	bit 4	running (including DC injection braking)	stopped	running	0010
	bit 5	for drive use	—	—	—
	bit 6	for drive use	—	—	—
	bit 7	tripped	not tripped	tripped	0080

Table 4: Input Terminal Status Monitor (register 32)

Lower Byte	Bit	Input Terminal	0	1	Single-Bit Read Mask
	bit 0	F	terminal - CC open	terminal - CC shorted	0001
	bit 1	R	terminal - CC open	terminal - CC shorted	0002
	bit 2	S1	terminal - CC open	terminal - CC shorted	0004
	bit 3	S2	terminal - CC open	terminal - CC shorted	0008
	bit 4	S3	terminal - CC open	terminal - CC shorted	0010
	bit 5	S4	terminal - CC open	terminal - CC shorted	0020
	bit 6	S5 (option)	terminal - CC open	terminal - CC shorted	0040
	bit 7	S6 (option)	terminal - CC open	terminal - CC shorted	0080

Upper Byte	Bit	Input Terminal	0	1	Single-Bit Read Mask
	bit 0	unused (always 0)	—	—	—
	bit 1	unused (always 0)	—	—	—
	bit 2	unused (always 0)	—	—	—
	bit 3	unused (always 0)	—	—	—
	bit 4	unused (always 0)	—	—	—
	bit 5	S7 (option)	terminal - CC open	terminal - CC shorted	0020
	bit 6	RES	terminal - CC open	terminal - CC shorted	0040
	bit 7	ST	terminal - CC open	terminal - CC shorted	0080

13.3.2 FUNDAMENTAL PARAMETERS #1 (U.F)

Register	Title		Bank	Mask	Adjustment Range	Multiplier
38	FH (*)		0 / 1	FFFF	0BB8 ~ 9C40 (30.00~400.00)	0.01
39	ULI		0 / 1	FFFF	09C4 ~ 9C40 (25.00~400.00)	0.01
40	ULSL (*)		0 / 1	0030	0000: Input voltage level (0) 0020: Automatic setting (1) 0030: Stationary setting (2)	—
41	ULUL		0 / 1	FFFF	0000 ~ 0258 (0 ~ 600)	1
42	dISr		0 / 1	0020	0000: Reverse allowed (0) 0020: Reverse not allowed (1)	—
43	UL		0 / 1	FFFF	0000 ~ FH	0.01
44	LL		0 / 1	FFFF	0000 ~ LL	0.01
45	Pt (*)		0 / 1	000F	0000: Constant torque (1) 0001: Variable torque (2) 0002: Automatic torque boost (3) 0006: Automatic torque boost with automatic energy savings (4) 000A: Vector control (5) 000E: Vector control with automatic energy savings (6)	—
46	1, 2	ubI	0 / 1	FFFF	0000 ~ 012C (0.0 ~ 30.0)	0.1
47	RECI		0 / 1	FFFF	0001 ~ EA60 (0.01~ 600.00) 0001 ~ EA60 (0.1~ 6000.0)	0.01 0.1
48	dECI		0 / 1	FFFF	0001 ~ EA60 (0.01~ 600.00) 0001 ~ EA60 (0.1~ 6000.0)	0.01 0.1
49	SCUI		0 / 1	0030	0000: Linear (0) 0010: Self-adjusting (1) 0020: S-Pattern #1 (2) 0030: S-Pattern #2 (3)	—
50	SCL		0 / 1	00FF	0003 ~ 00FD (0 ~ 50) (Note 1)	1
51	SCH		0 / 1	00FF	0003 ~ 00FD (0 ~ 50) (Note 1)	1

Note 1: When writing to these parameters, the written data = (desired setting x 5 + 3), converted to hexadecimal.
When reading from these parameters, the actual setting = ([register data converted to decimal - 3] ÷ 5).

13.3.3 FUNDAMENTAL PARAMETERS #2 (U_r.F₂)

Register	Title	Bank	Mask	Adjustment Range	Multiplier
52	uL2	0 / 1	FFFF	09C4 ~ 9C40 (25.00 ~ 400.00)	0.01
53	uLu2	0 / 1	FFFF	0000 ~ 0258 (0 ~ 600)	1
54	ub2	0 / 1	FFFF	0000 ~ 012C (0.0 ~ 30.0)	0.1
55	tHr2	0 / 1	00FF	000A ~ 0064 (10 ~ 100)	1
56	StC2	0 / 1	0040	0000: ON (0) 0040: OFF (1)	—
57	0 StL2	0 / 1	00FF	000A ~ 00D7 (10 ~ 215)	1
58	RCC2	0 / 1	FFFF	0001 ~ EA60 (0.1~ 6000.0) 0001 ~ EA60 (0.01~ 600.00)	0.1 0.01
59	dCC2	0 / 1	FFFF	0001 ~ EA60 (0.1~ 6000.0) 0001 ~ EA60 (0.01~ 600.00)	0.1 0.01
60	SCu2	0 / 1	0030	0000: Linear (0) 0010: Self-adjusting (1) 0020: S-Pattern #1 (2) 0030: S-Pattern #2 (3)	—
61	Rd2F	0 / 1	FFFF	0000 ~ FH	0.01

13.3.4 PANEL CONTROL PARAMETERS (U_r.P_n)

Register	Title	Bank	Mask	Adjustment Range	Multiplier
62	F _r	0 / 1	0004	0000: Reverse (0) 0004: Forward (1)	—
63	StPP	0 / 1	0040	0000: Decelerated stop (0) 0040: Coast stop (1)	—
64	PtP	0 / 1	0004	0000: V/F #1 (1) 0004: V/F #2 (2)	—
65	Rd2	0 / 1	0008	0000: Acc / dec #1 (1) 0008: Acc / dec #2 (2)	—
66	P _r ES	0 / 1	0030	0000: All possible (0) 0010: OL only (1) 0020: OL, OC only (2)	—
67	PFbC	0 / 1	0001	0000: Feedback valid (0) 0001: Feedback invalid (1)	—
68	SFLY (E3 only)	0 / 1	0080	0000: OFF (0) 0080: ON (1)	—

13.3.5 TERMINAL SELECTION PARAMETERS (設定)

Register	Title		Bank	Mask	Adjustment Range	Multiplier
69	I		0 / 1	0001	0000: Standard functions (0) 0001: Individual selections (1)	—
70	1	I0	0 / 1	FFFF	0000 ~ FFFF (0 ~ 56) Refer to Table 5 (page 42) I adjustment range is 0 ~ 42	—
71		I1				
72		I2				
73		I3				
74		I4				
75		I5				
76		I6				
77		I7				
78		I8				
79		I9				
80		I10				
81		I11				
82	IF		0 / 1	00FF	0001 ~ 0064 (1 ~ 100)	1
83	ISF		0 / 1	00FF	0001 ~ 0064 (1 ~ 100)	1
84	IS6F		0 / 1	00FF	0001 ~ 0064 (1 ~ 100)	1
85	I7F		0 / 1	00FF	0001 ~ 0064 (1 ~ 100)	1
86	O0		0 / 1	FFFF	0000 ~ FFFF (0 ~ 67) Refer to Table 6 (page 43)	—
87	O0d		0 / 1	00FF	0001 ~ 0064 (1 ~ 100)	1
88	O0h		0 / 1	00FF	0001 ~ 0064 (1 ~ 100)	1
89	O1		0 / 1	FFFF	0000 ~ FFFF (0 ~ 67) Refer to Table 6 (page 43)	—
90	O1d		0 / 1	00FF	0001 ~ 0064 (1 ~ 100)	1
91	O1h		0 / 1	00FF	0001 ~ 0064 (1 ~ 100)	1
92	O2		0 / 1	FFFF	0000 ~ FFFF (0 ~ 67) Refer to Table 6 (page 43)	—
93	O2d		0 / 1	00FF	0001 ~ 0064 (1 ~ 100)	1
94	O2h		0 / 1	00FF	0001 ~ 0064 (1 ~ 100)	1
95	O3		0 / 1	FFFF	0000 ~ FFFF (0 ~ 67) Refer to Table 6 (page 43)	—
96	O3d		0 / 1	00FF	0001 ~ 0064 (1 ~ 100)	1
97	O3h		0 / 1	00FF	0001 ~ 0064 (1 ~ 100)	1
98	LF		0 / 1	FFFF	0 ~ FH	0.01
99	b rCH		0 / 1	FFFF	0 ~ FH	0.01
100	H rCH		0 / 1	FFFF	0 ~ FH	0.01
101	L rCH		0 / 1	FFFF	0 ~ FH	0.01
102	CCHG		0 / 1	00C0	0000: OFF (0) 0040: Automatic switch on trip (1) 0080: Switch at FCHG setting (2) 00C0: Both (1) and (2) (3)	—
103	2, 3	FCHG	0 / 1	FFFF	0 ~ FH	0.01
104	O4FP		0 / 1	0003	0000: 48f (0) 0001: 96f (1) 0002: 360f (2)	—
105	Inrr		0 / 1	00E0	0000: Standard (0) 0040: FH (1) 0080: TACC/TDEC multiplier (2) 00C0: VB multiplier (3) 0020: CL multiplier (4)	—

Table 5: Input Terminal Selections

Setting Value	Data (Hex)	Function	Setting Value	Data (Hex)	Function
0	10C8	R (reverse run)	29	08AF	Binary bit #7
1	011C	SS1 (preset speed selection)	30	10AF	Binary bit #8
2	021C	SS2 (preset speed selection)	31	20AF	Binary bit #9
3	041C	SS3 (preset speed selection)	32	40AF	Binary bit #10
4	081C	SS4 (preset speed selection)	33	04CE	No effect
5	20C8	F (forward run)	34	01C7	UP/DOWN frequency setting (UP)
6	201B	RES (fault reset)	35	02C7	UP/DOWN frequency setting (DOWN)
7	C0C9	ST (gate ON/OFF)	36	04C7	UP/DOWN frequency clear
8	0CC8	JOG selection	37	08C7	PUSH-type RUN key
9	081A	Accel/decel #1/#2 selection	38	10C7	PUSH-type STOP key
10	101B	Emergency off	39	02B9	No effect
11	021B	DC injection braking ON/OFF	40	C0C8	Forward/reverse run selection
12	041B	Fundamental parameter switching (V/F #1/#2 selection)	41	20C7	RUN
13	011B	Feedback control ON/OFF	42	30C9	Binary data write
14	10CE	Pattern run selection #1	43	0198	[PANEL/REMOTE] key
15	20CE	Pattern run selection #2	44	0298	[MON] key
16	40CE	Pattern run selection #3	45	0498	[PRG] key
17	80CE	Pattern run selection #4	46	0898	[UP] key
18	02CE	Pattern run continue signal	47	1098	[DOWN] key
19	01CE	Pattern run step trigger signal	48	2098	[ENTER] key
20	0AC9	JOG forward run	49	4098	[RUN] key
21	06C9	JOG reverse run	50	8098	[STOP/RESET] key
22	10AE	Binary bit #0	51	08CE	Commercial power / drive switching signal
23	20AE	Binary bit #1	52	40C7	Reserved for option use
24	40AE	Binary bit #2	53	10CB	RR frequency switching input
25	80AE	Binary bit #3	54	20CB	IV frequency switching input
26	01AF	Binary bit #4	55	80EA	Damper status input (E3 only)
27	02AF	Binary bit #5	56	80C7	Firespeed ON/OFF (E3 only)
28	04AF	Binary bit #6			

Note: In order for binary bit #0 ~ #10 (setting values 22 ~ 32) and UP/DOWN frequency setting (setting values 34 & 35) inputs to be valid, frequency priority selection #1 (F₁) or frequency priority selection #2 (F₂) in C₁.5F must be set to 5 (BIN - binary setting or UP/DOWN setting).

Table 6: Output Terminal Selections (RCH, LOW, FL, OUT)

Setting Value	Data (Hex)	Function	Setting Value	Data (Hex)	Function
0	0000	Lower limit frequency (LL)	34	B5BB	Executing retry
1	0100	/Lower limit frequency (LL)	35	BDBB	/Executing retry
2	0200	Upper limit frequency (UL)	36	D5CF	Pattern run switching output
3	0300	/Upper limit frequency (UL)	37	DDCF	/Pattern run switching output
4	0400	Low speed signal	38	D5D8	PID deviation limit
5	0500	/Low speed signal	39	DDD8	/PID deviation limit
6	F2EE (E3 ASD) 0600 (other)	Accel/decel complete	40	C5BB	Run/stop
7	FAEE (E3 ASD) 0700 (other)	/Accel/decel complete	41	CDBB	/Run/stop
8	0800	Selected speed reach signal	42	1400	Severe fault (armature short, load-end short, open phase, output error, earth fault)
9	0900	/Selected speed reach signal	43	1500	/Severe fault (armature short, load-end short, open phase, output error, earth fault)
10	0A00	Fault	44	1600	Non-severe fault (overload, overcurrent, overvoltage)
11	0B00	/Fault	45	1700	/Non-severe fault (overload, overcurrent, overvoltage)
12	0C00	Fault other than earth fault or load-end overcurrent	46	E5D8	Commercial power / drive switching output #1
13	0D00	/Fault other than earth fault or load-end overcurrent	47	EDD8	/Commercial power / drive switching output #1
14	95B5	Overcurrent pre-alarm	48	F5D8	Commercial power / drive switching output #2
15	9DB5	/Overcurrent pre-alarm	49	FDD8	/Commercial power / drive switching output #2
16	85C5	Drive overload pre-alarm	50	85C0	Fan ON/OFF
17	8DC5	/Drive overload pre-alarm	51	8DC0	/Fan ON/OFF
18	95C5	Motor overload pre-alarm	52	F5B6	Executing JOG
19	9DC5	/Motor overload pre-alarm	53	FDB6	/Executing JOG
20	D5C5	Overheat pre-alarm	54	1800	Local/remote operation
21	DDC5	/Overheat pre-alarm	55	1900	/Local/remote operation
22	A5B4	Overvoltage pre-alarm	56	A5D1	Cumulative timer alarm
23	ADB4	/Overvoltage pre-alarm	57	ADD1	/Cumulative timer alarm
24	E5B4	Undervoltage alarm	58	1A00	Communication error alarm
25	EDB4	/Undervoltage alarm	59	1B00	/Communication error alarm
26	85B5	Undercurrent alarm	60	A5B6	F/R
27	8DB5	/Undercurrent alarm	61	ADB6	/F/R
28	85D1	Overtorque alarm	62	1E00	Run preparation complete
29	8DD1	/Overtorque alarm	63	1F00	/Run preparation complete
30	E5BB	Braking resistor OL pre-alarm	64	E5BD	Damper open (E3 only)
31	EDBB	/Braking resistor OL pre-alarm	65	EDBD	/Damper open (E3 only)
32	C5B7	Executing emergency off	66	E5CB	IV analog input loss (E3 only)
33	CDB7	/Executing emergency off	67	EDCB	/IV analog input loss (E3 only)

13.3.6 SPECIAL CONTROL PARAMETERS (CF.CF)

Register	Title	Bank	Mask	Adjustment Range	Multiplier	
106~110	Reserved	—	—	—	—	
111	F-Set	0 / 1	FFFF	0000 ~ 03E8 (0.00 ~ 10.00)	0.01	
112	F-En	0 / 1	FFFF	0000 ~ 0BB8 (0.00 ~ 30.00)	0.01	
113	F-run	0 / 1	FFFF	0000 ~ FH	0.01	
114	FHY5	0 / 1	FFFF	0000 ~ 0BB8 (0.00 ~ 30.00)	0.01	
115	Fdn	0 / 1	0080	0000: Function OFF (0) 0080: Function ON (1)	—	
116	1	FJ1	0 / 1	FFFF	0000 ~ FH	0.01
117		bFJ1	0 / 1	FFFF	0000 ~ 0BB8 (0.00 ~ 30.00)	0.01
118		FJ2	0 / 1	FFFF	0000 ~ FH	0.01
119		bFJ2	0 / 1	FFFF	0000 ~ 0BB8 (0.00 ~ 30.00)	0.01
120		FJ3	0 / 1	FFFF	0000 ~ FH	0.01
121		bFJ3	0 / 1	FFFF	0000 ~ 0BB8 (0.00 ~ 30.00)	0.01
122	CF	0 / 1	00FF	<ul style="list-style-type: none"> 0005 ~ 00AA (0.5 ~ 17.0) 15kW and smaller 0005 ~ 0096 (0.5 ~ 15.0) 18.5kW and larger 	0.1	
123~128	Reserved	—	—	—	—	

13.3.7 FREQUENCY SETTING PARAMETERS (Gr.5F)

Register	Title	Bank	Mask	Adjustment Range	Multiplier	
129	FC1	0 / 1	0007	0001: RR (1) 0002: IV (2) 0003: RX (3) 0004: PG (4) 0005: BIN (5)	—	
130	FC2	0 / 1	0038	0008: RR (1) 0010: IV (2) 0018: RX (3) 0020: PG (4) 0028: BIN (5)	—	
131	lnF	0 / 1	0003	0000: No filter (0) 0001: Small filter (1) 0002: Medium filter (2) 0003: Large filter (3)	—	
132	rr ln	0 / 1	0002	0000: Standard (0) 0002: Adjustable (1)	—	
133	1	P1	0 / 1	00FF	0000 ~ 0064 (0 ~ 100)	1
134		F-P1	0 / 1	FFFF	0000 ~ FH	0.01
135		P2	0 / 1	00FF	0000 ~ 0064 (0 ~ 100)	1
136		F-P2	0 / 1	FFFF	0000 ~ FH	0.01
137	lu ln	0 / 1	0004	0000: Standard (0) 0004: Adjustable (1)	—	
138	1	P3	0 / 1	00FF	0000 ~ 0064 (0 ~ 100)	1
139		F-P3	0 / 1	FFFF	0000 ~ FH	0.01
140		P4	0 / 1	00FF	0000 ~ 0064 (0 ~ 100)	1
141		F-P4	0 / 1	FFFF	0000 ~ FH	0.01
142	re ln	0 / 1	0008	0000: Standard (0) 0008: Adjustable (1)	—	
143	1	P5	0 / 1	00FF	009C ~ 00FF, 0000 ~ 0064 (-100 ~ -1, 0 ~ 100)	1
144		F-P5	0 / 1	FFFF	-FH ~ FH	0.02
145		P6	0 / 1	00FF	009C ~ 00FF, 0000 ~ 0064 (-100 ~ -1, 0 ~ 100)	1
146		F-P6	0 / 1	FFFF	-FH ~ FH	0.02
147	PG ln	0 / 1	0010	0000: Standard (0) 0010: Adjustable (1)	—	
148	1	P7	0 / 1	00FF	009C ~ 00FF, 0000 ~ 0064 (-100 ~ -1, 0 ~ 100)	1
149		F-P7	0 / 1	FFFF	-FH ~ FH	0.02
150		P8	0 / 1	00FF	009C ~ 00FF, 0000 ~ 0064 (-100 ~ -1, 0 ~ 100)	1
151		F-P8	0 / 1	FFFF	-FH ~ FH	0.02
152	bl ln	0 / 1	0001	0000: Standard (0) 0001: Adjustable (1)	—	
153	1	P9	0 / 1	00FF	0000 ~ 0064 (0 ~ 100)	1
154		F-P9	0 / 1	FFFF	-FH ~ FH	0.02
155		PA	0 / 1	00FF	0000 ~ 0064 (0 ~ 100)	1
156		F-PA	0 / 1	FFFF	-FH ~ FH	0.02

Register	Title		Bank	Mask	Adjustment Range	Multiplier
157	JDC		0 / 1	FFFF	0000 ~ 07D0 (0.00 ~ 20.00)	0.01
158	Other than 0	JSTEP	0 / 1	00C0	0000: Decelerated stop (0) 0040: Coast stop (1) 0080: DC injection stop (2)	—
159	Srn		0 / 1	000F	0000 ~ 000F (0 ~ 15)	1
160~255	Reserved		—	—	—	—
256	Other than 0	Sr01	0 / 1	0004	0000: Deactivated (0) 0004: Activated (1)	—
257		F50r	1	FFFF	LL ~ UL	0.01
258		Sr01	1	040C	0004: (0) 0000: (1) 000C: (2) 0008: (3) 0404: (4) 0400: (5) 040C: (6) 0408: (7)	1
259	2 or higher	Sr02	1	FFFF	LL ~ UL	0.01
260		Sr02	1	040C	Same as Sr01	1
261	3 or higher	Sr03	1	FFFF	LL ~ UL	0.01
262		Sr03	1	040C	Same as Sr01	1
263	4 or higher	Sr04	1	FFFF	LL ~ UL	0.01
264		Sr04	1	040C	Same as Sr01	1
265	5 or higher	Sr05	1	FFFF	LL ~ UL	0.01
266		Sr05	1	040C	Same as Sr01	1
267	6 or higher	Sr06	1	FFFF	LL ~ UL	0.01
268		Sr06	1	040C	Same as Sr01	1
269	7 or higher	Sr07	1	FFFF	LL ~ UL	0.01
270		Sr07	1	040C	Same as Sr01	1
271	8 or higher	Sr08	1	FFFF	LL ~ UL	0.01
272		Sr08	1	040C	Same as Sr01	1
273	9 or higher	Sr09	1	FFFF	LL ~ UL	0.01
274		Sr09	1	040C	Same as Sr01	1
275	10 or higher	Sr10	1	FFFF	LL ~ UL	0.01
276		Sr10	1	040C	Same as Sr01	1
277	11 or higher	Sr11	1	FFFF	LL ~ UL	0.01
278		Sr11	1	040C	Same as Sr01	1
279	12 or higher	Sr12	1	FFFF	LL ~ UL	0.01
280		Sr12	1	040C	Same as Sr01	1
281	13 or higher	Sr13	1	FFFF	LL ~ UL	0.01
282		Sr13	1	040C	Same as Sr01	1
283	14 or higher	Sr14	1	FFFF	LL ~ UL	0.01
284		Sr14	1	040C	Same as Sr01	1
285	15	Sr15	1	FFFF	LL ~ UL	0.01
286		Sr15	1	040C	Same as Sr01	1

13.3.8 PROTECTION FUNCTION PARAMETERS (C₁.P₁)

Register	Title		Bank	Mask	Adjustment Range	Multiplier
287	Pb		0 / 1	0003	0000: no dynamic braking (0) 0001: with dynamic braking, no DBR overload trip (1) 0003: with dynamic braking and DBR overload trip (2)	—
288	2	Pbr	0 / 1	FFFF	000A ~ 2710 (1.0 ~ 1000)	0.1
289		PbCP	0 / 1	FFFF	0001 ~ EA60 (0.01 ~ 600.00)	0.01
290	OPSS		0 / 1	0004	0000: ON (0) 0004: OFF (1)	—
291	dbF		0 / 1	FFFF	0000 ~ 2EE0 (0.00 ~ 120.00)	0.01
292	Other than 0	dbC	0 / 1	00FF	0000 ~ 0064 (0 ~ 100)	1
293		dbE	0 / 1	00FF	0000 ~ 0064 (0.0 ~ 10.0)	0.1
294	dbSL		0 / 1	0040	0000: OFF (0) 0040: ON (1)	—
295	db In		0 / 1	0080	0000: OFF (0) 0080: ON (1)	—
296	ESTP		0 / 1	0030	0000: Coast stop (0) 0010: Decelerated stop (1) 0020: DC injection stop (2)	—
297	2	EdbE	0 / 1	00FF	0000 ~ 0064 (0.0 ~ 10.0)	0.1
298	rErY		0 / 1	00FF	0000 ~ 000A (0 ~ 10)	1
299	Other than 0	rEtE	0 / 1	00FF	0000 ~ 0064 (0.0 ~ 10.0)	0.1
300	UUC		0 / 1	0008	0000: OFF (0) 0008: ON (1)	—
301	1	UUCt	0 / 1	00FF	0000 ~ 00FA (0.0 ~ 25.0)	0.1
302	ArSt		0 / 1	0018	0000: OFF (0) 0008: On power failure (1) 0010: On ST make/break (2) 0018: Both (1) and (2) (3)	—
303	tEr I		0 / 1	00FF	000A ~ 0064 (10 ~ 100)	1
304	OLF		0 / 1	FFFF	0000 ~ 0BB8 (0.00 ~ 30.00)	0.01
305	OLt		0 / 1	00FF	0001 ~ 00F0 (10 ~ 2400)	10
306	OLn		0 / 1	0030	0000: with motor overload trip, without soft-stall (0) 0010: with motor overload trip and soft-stall (1) 0020: without soft-stall or motor overload trip (2) 0030: with soft-stall, without motor overload trip (3)	—
307	StE I		0 / 1	0040	0000: ON (0) 0040: OFF (1)	—
308	0	StE I	0 / 1	00FF	000A ~ 00D7 (10 ~ 215)	1

Register	Title	Bank	Mask	Adjustment Range	Multiplier	
309	UPSL	0 / 1	0080	0000: Trip disabled (0) 0080: Trip (during run) (1)	—	
310	UPE	0 / 1	FFFF	0000 ~ 03E8 (0.00 ~ 10.00)	0.01	
311	LLP	0 / 1	0008	0000: Trip disabled (0) 0008: Trip on detection (1)	—	
312	LLPE	0 / 1	00FF	0000 ~ 0064 (0 ~ 100)	1	
313	LLPE	0 / 1	00FF	0000 ~ 00FF (0 ~ 255)	1	
314-316	Reserved	—	—	—	—	
317	OCLS	0 / 1	0003	0000: Standard motor (0) 0001: High-speed motor (1) 0002: Positioning use (standard motor) (2) 0003: Positioning use (high-speed motor) (3)	—	
318	OCSL	0 / 1	0040	0000: Trip disabled (0) 0040: Trip enabled (1)	—	
319	OCCL	0 / 1	00FF	0000 ~ 00C8 (0 ~ 200)	1	
320	OCCL	0 / 1	0002	0000: Data cleared when powered OFF (0) 0002: Data retained when powered OFF (1)	—	
321	FRn	0 / 1	0004	0000: Automatic (temperature detection) (0) 0004: Always ON (1)	—	
322	OUE	0 / 1	FFFF	0000 ~ C34B (0.00 ~ 999.90)	0.02	
323	LR15 (E3 only)	0 / 1	00E0	0000: Do nothing (0) 0020: Run at LL (1) 0040: Run at UL (2) 0060: Trip "LOS5" (3) 0080: Run at PD15 % of FC (4)	—	
324	1 ~ 4	PD15 (E3 only)	0 / 1	00FF	0000 ~ 0064 (0 ~ 100%)	1
325		td (E3 only)	0 / 1	00FF	0003 ~ 000A (0.3 ~ 1.0s)	0.1
326-331	Reserved	—	—	—	—	

13.3.9 PATTERN RUN CONTROL PARAMETERS (Cur.Pt)

Register	Title	Bank	Mask	Adjustment Range	Multiplier
332	PSEL	0 / 1	0008	0000: OFF (0) 0008: ON (1)	—
333	Pt0	0 / 1	0001	0000: reset on stop (0) 0001: switch when done (1)	—
334	Pt10	1	00FF	0000: Skip (0) 0001 ~ 000F: Speeds 1 ~ 15	1
335	Pt11				
336	Pt12				
337	Pt13				
338	Pt14				
339	Pt15				
340	Pt16				
341	Pt17				
342	PtL1	0 / 1	00FF	0001 ~ 00FF: 1 ~ 255	1
343	Pt20	1	00FF	0000: Skip (0) 0001 ~ 000F: Speeds 1 ~ 15	1
344	Pt21				
345	Pt22				
346	Pt23				
347	Pt24				
348	Pt25				
349	Pt26				
350	Pt27				
351	PtL2	0 / 1	00FF	0001 ~ 00FF: 1 ~ 255	1
352	Pt30	1	00FF	0000: Skip (0) 0001 ~ 000F: Speeds 1 ~ 15	1
353	Pt31				
354	Pt32				
355	Pt33				
356	Pt34				
357	Pt35				
358	Pt36				
359	Pt37				
360	PtL3	0 / 1	00FF	0001 ~ 00FF: 1 ~ 255	1
361	Pt40	1	00FF	0000: Skip (0) 0001 ~ 000F: Speeds 1 ~ 15	1
362	Pt41				
363	Pt42				
364	Pt43				
365	Pt44				
366	Pt45				
367	Pt46				
368	Pt47				
369	PtL4	0 / 1	00FF	0001 ~ 00FF: 1 ~ 255	1

Register	Title		Bank	Mask	Adjustment Range	Multiplier
370		SLA1	1	00FF	0000: Count in seconds from time of activation (0) 0001: Count in minutes from time of activation (1) 0002: Count in seconds from speed reach (2) 0003: Count in minutes from speed reach (3) 0004: Non-stop (continue until STOP command) (4) 0005: Continue until next step command (5)	—
371	< 4	SLB1	1	FFFF	0000 ~ 1F40 (0 ~ 8000)	1
372		SLA2	1	00FF	Same as SLA1	—
373	< 4	SLB2	1	FFFF	0000 ~ 1F40 (0 ~ 8000)	1
374		SLA3	1	00FF	Same as SLA1	—
375	< 4	SLB3	1	FFFF	0000 ~ 1F40 (0 ~ 8000)	1
376		SLA4	1	00FF	Same as SLA1	—
377	< 4	SLB4	1	FFFF	0000 ~ 1F40 (0 ~ 8000)	1
378		SLA5	1	00FF	Same as SLA1	—
379	< 4	SLB5	1	FFFF	0000 ~ 1F40 (0 ~ 8000)	1
380		SLA6	1	00FF	Same as SLA1	—
381	< 4	SLB6	1	FFFF	0000 ~ 1F40 (0 ~ 8000)	1
382		SLA7	1	00FF	Same as SLA1	—
383	< 4	SLB7	1	FFFF	0000 ~ 1F40 (0 ~ 8000)	1
384		SLA8	1	00FF	Same as SLA1	—
385	< 4	SLB8	1	FFFF	0000 ~ 1F40 (0 ~ 8000)	1
386		SLA9	1	00FF	Same as SLA1	—
387	< 4	SLB9	1	FFFF	0000 ~ 1F40 (0 ~ 8000)	1
388		SLAA	1	00FF	Same as SLA1	—
389	< 4	SLBA	1	FFFF	0000 ~ 1F40 (0 ~ 8000)	1
390		SLAB	1	00FF	Same as SLA1	—
391	< 4	SLBB	1	FFFF	0000 ~ 1F40 (0 ~ 8000)	1
392		SLAC	1	00FF	Same as SLA1	—
393	< 4	SLBC	1	FFFF	0000 ~ 1F40 (0 ~ 8000)	1
394		SLAD	1	00FF	Same as SLA1	—
395	< 4	SLBD	1	FFFF	0000 ~ 1F40 (0 ~ 8000)	1
396		SLAE	1	00FF	Same as SLA1	—
397	< 4	SLBE	1	FFFF	0000 ~ 1F40 (0 ~ 8000)	1
398		SLAF	1	00FF	Same as SLA1	—
399	< 4	SLBF	1	FFFF	0000 ~ 1F40 (0 ~ 8000)	1

13.3.10 FEEDBACK CONTROL PARAMETERS (Ctrl.Fb)

Register	Title		Bank	Mask	Adjustment Range	Multiplier
400	FbP1		0 / 1	0060	0020: No feedback (0) 0040: PID control (1) 0060: Speed feedback (2)	—
401	1, 2	FbIn	0 / 1	001C	0004: RR input (1) 0008: IV input (2) 000C: RX input (3) 0010: PG feedback (4) 0014: RS232C input (5) 0018: Communication/12-bit binary interface board (6) 001C: BIN input (7)	—
402		CP	0 / 1	00FF	0001 ~ 00FF (0.01 ~ 2.55)	0.01
403		CI	0 / 1	FFFF	0001 ~ 8CA0 (0.01 ~ 360.00)	0.01
404		CR	0 / 1	00FF	0000 ~ 00FF (0.0 ~ 25.5)	0.1
405		CFS	0 / 1	00FF	0000 ~ 00FF (0 ~ 255)	1
406	1	PILL	0 / 1	FFFF	0 ~ FH	0.01
407	PUL		0 / 1	0080	0000: No PID deviation limit (0) 0080: PID deviation limited (1)	—
408	1	PULW	0 / 1	00FF	0000 ~ 0032 (0 ~ 50)	1
409		PULL	0 / 1	00FF	0000 ~ 0032 (0 ~ 50)	1
410	PG		0 / 1	FFFF	0001 ~ 270F (1 ~ 9999)	1
411	PCPH		0 / 1	0001	0000: Single-phase input (1) 0001: Two-phase input (2)	—
412	drPE		0 / 1	0002	0000: OFF (0) 0002: ON (1)	—
413	1	drPEt	0 / 1	00FF	0000 ~ 0064 (0 ~ 10.0)	0.1
414	Ord1		0 / 1	0007	0000: OFF (0) 0001: FCRR (1) 0002: FCIV (2) 0003: FCRX (3) 0004: FCPG (4) 0005: FCPNL (5) 0006: FCOPT (6) 0007: FCMLT (7)	—
415	7	Ord2	0 / 1	0038	0000: Reference (0) 0008: KRR (1) 0010: KIV (2) 0018: KRX (3) 0020: KBIN (4)	—
416		Ord3	0 / 1	FFFF	FC18 ~ 03E8 (-100.0 ~ 100.0)	0.1
417~512	Reserved		—	—	—	—

13.3.11 COMMUNICATION SETTING PARAMETERS (C.R.T.R)

Register	Title		Bank	Mask	Adjustment Range	Multiplier
513	brt2		1	0018	0000: 2400 baud (0) 0008: 4800 baud (1) 0010: 9600 baud (2)	—
514	sn78		1	0040	0000: 7 bits (0) 0040: 8 bits (1)	—
515	snEO		1	0080	0000: Even parity (0) 0080: Odd parity (1)	—
516	Ino		1	00FF	0000 ~ 00FF (0 ~ 255)	1
517	OPE		1	0007	0000: OFF (0) 0001: RS485 (1) 0002: LONWORKS, Modbus, F10 (2) 0003: TOSLINE S-20 (3) 0004: 12 bit binary input (4) 0005: 3-digit BCD (0.1Hz) (5) 0006: 3-digit BCD (1Hz) (6)	—
518	1	rst	1	0018	0000: Slave (0) 0008: Master (frequency cmd.) (1) 0010: Master (output frequency) (2)	—
519		brt4	1	0004	0000: Normal mode (0) 0004: High-speed mode (1)	—
520	2	Pin	1	0003	0000: OFF (0) 0001: Frequency command (1) 0002: Command input (2) 0003: Both (1) and (2) (3)	—
521		POUE	1	003C	0000: (0) 0020: (8) 0004: (1) 0024: (9) 0008: (2) 0028: (10) 000C: (3) 002C: (11) 0010: (4) 0030: (12) 0014: (5) 0034: (13) 0018: (6) 0038: (14) 001C: (7) 003C: (15)	—
522		PErr	1	0080	0000: Data cleared (0) 0080: Data retained (1)	—
523	3	InR	1	FFFF	0000 ~ 03FF (0 ~ 1023)	1
524		OUER	1	FFFF	0000 ~ 03FF (0 ~ 1023)	1
525		S In	1	001F	0000 ~ 001F (0 ~ 31)	1
526		SOUE	1	001F	0000 ~ 001F (0 ~ 31)	1
527		F InS	1	0001	0000: Disable (0) 0001: Enable (1)	1
528		1 F InR	1	FFFF	0000 ~ 03FF (0 ~ 1023)	1
529		SErr	1	0002	0000: Data cleared (0) 0002: Data retained (1)	1
530		Srt	1	0004	0000: No effect (0) 0004: Reset (1)	1
531	Er In		0 / 1	0020	0000: OFF (0) 0020: ON (1)	—
532	1	PL	0 / 1	00FF	0000 ~ 0064 (0 ~ 100)	1
533		F-PL	0 / 1	FFFF	0000 ~ FH	0.01
534		PH	0 / 1	00FF	0000 ~ 0064 (0 ~ 100)	1
535		F-PH	0 / 1	FFFF	0000 ~ FH	0.01

13.3.12 AM/FM ADJUSTMENT PARAMETERS (Cr.Fn)

Register	Title	Bank	Mask	Adjustment Range	Multiplier
536	FNSL	0 / 1	FFFF	1194: Pre-comp ref. freq. (E3) (0)	—
				1524: Pre-comp ref. freq. (other) (0)	
				6686: Post-comp output freq. (1)	
				1500: Frequency setting (2)	
				2576: Output current (3)	
				2689: DC voltage (4)	
				5668: Output voltage (5)	
				3684: Torque current (6)	
				2688: Excitation current (7)	
				7506: PID feedback value (8)	
				0584: Motor overload ratio (9)	
				0586: Drive overload ratio (10)	
				0588: DBR overload ratio (11)	
				835C: Input power (12)	
				835E: Output power (13)	
				A000: Fixed output (14)	
2304: Peak output current (15)					
8302: Peak input voltage (16)					
537	FN	0 / 1	FFFF	0000 ~ FFFF	1
538	RNSL	0 / 1	FFFF	Same as FNSL	—
539	RN	0 / 1	FFFF	0000 ~ FFFF	1

13.3.13 UTILITY PARAMETERS (U.P.L.T)

Register	Title	Bank	Mask	Adjustment Range	Multiplier
540	RPL (previous setting monitor for read use only)	0 / 1	00FF	0000: Std. shipment setting (0) 0001: Pump application (1) 0002: Fan application (2) 0003: Conveyor application (3) 0004: Hoist application (4) 0005: Textiles application (5) 0006: Machine tools application (6)	—
541	RPL (for write use) (*)	0 / 1	00FF	0000: Does nothing (0) 0011: Pump application (1) 0012: Fan application (2) 0013: Conveyor application (3) 0014: Hoist application (4) 0015: Textiles application (5) 0016: Machine tools application (6)	—
542	TYPE (*)	0 / 1	00FF	0000: Does nothing (0) 0001: 50Hz std. settings (1) 0002: 60Hz std. settings (2) 0003: Factory settings (3) 0004: Trip clear (4) 0005: Save user-set parameters (5) 0006: TYPE 5 reset (6) 0007: Initialize typeform (7)	—
543	EN00d	0 / 1	0007	0000: Only RS232C valid (0) 0001: Terminal input valid (1) 0002: Panel input valid (2) 0003: Communication interface input valid (3) 0004: local/remote valid (4)	—
544	EN00d	0 / 1	0038	0000: Only RS232C valid (0) 0008: Terminal input valid (1) 0010: Panel input valid (2) 0018: Communication/12-bit binary interface input valid (3) 0020: local/remote valid (4)	—
545	PR00d	0 / 1	00FB	0000 ~ 003F (0 ~ 63) (except 0004, 0008, 000C....)	1
546	PR55	0 / 1	00FF	0000 ~ 0063 (0 ~ 99)	1
547	uCPU	2	FFFF	(Monitor only)	—
548	Reserved	—	—	—	—
549	uEEP	1	FFFF	(Monitor only)	—
550	FORN	0	00FF	Refer to section 13.4 (page 57)	—
551	Non1	0 / 1	FFFF	0001 ~ 0012 (1 ~ 18): E3 ASD 0001 ~ 0010 (1 ~ 16): other ASD	1
552	Non2	0 / 1	FFFF		1
553	Non3	0 / 1	FFFF		1
554	Non4	0 / 1	FFFF		1
555	dSP2	0 / 1	FFFF	0000 ~ 4E20 (0.00 ~ 200.00)	0.01
556	dSPF	0 / 1	0003	0000: 1Hz (0) 0001: 0.1Hz (1) 0002: 0.01Hz (2)	—

Register	Title	Bank	Mask	Adjustment Range	Multiplier
557	dSPt	0 / 1	0004	0000: 0.1 sec. (0) 0004: 0.01 sec. (1)	—
558	dSPC	0 / 1	0008	0000: % (0) 0008: A (1)	—
559	dSPu	0 / 1	0010	0000: % (0) 0010: V (1)	—
560	bLnd	0 / 1	0001	0000: Blind (0) 0001: Selective unblinding (1)	—
561	bLF2	0 / 1	0040	0000: Blind (0) 0040: Unblind (1)	—
562	bLPn	0 / 1	0080	0000: Blind (0) 0080: Unblind (1)	—
563	bLSt	0 / 1	0001	0000: Blind (0) 0001: Unblind (1)	—
564	bLSc	0 / 1	0002	0000: Blind (0) 0002: Unblind (1)	—
565	bLSF	0 / 1	0004	0000: Blind (0) 0004: Unblind (1)	—
566	bLPr	0 / 1	0008	0000: Blind (0) 0008: Unblind (1)	—
567	bLPt	0 / 1	0010	0000: Blind (0) 0010: Unblind (1)	—
568	bLfb	0 / 1	0020	0000: Blind (0) 0020: Unblind (1)	—
569	bLfr	0 / 1	0040	0000: Blind (0) 0040: Unblind (1)	—
570	bL01	0 / 1	0080	0000: Blind (0) 0080: Unblind (1)	—
571	bL02	0 / 1	0001	0000: Blind (0) 0001: Unblind (1)	—
572	bL03	0 / 1	0002	0000: Blind (0) 0002: Unblind (1)	—
573	bL04	0 / 1	0004	0000: Blind (0) 0004: Unblind (1)	—
574	bL05	0 / 1	0008	0000: Blind (0) 0008: Unblind (1)	—
575	bL06	0 / 1	0010	0000: Blind (0) 0010: Unblind (1)	—
576	bLr0	0 / 1	0001	0000: Blind (0) 0001: Unblind (1)	—
577	bLrt	0 / 1	0004	0000: Blind (0) 0004: Unblind (1)	—

13.3.14 MOTOR RATING PARAMETERS (ፎር.ቤፎ)

Register	Title	Bank	Mask	Adjustment Range	Multiplier
578	ቤፎፑ	0 / 1	00FF	0001: (2) 0002: (4) 0003: (6) 0004: (8) 0005: (10) 0006: (12) 0007: (14) 0008: (16)	2
579	ቤፎረ	0 / 1	FFFF	0001 ~ 270F (0.1 ~ 999.9)	0.1
580	ቤፎፎ	0 / 1	0030	0000:Toshiba standard motor (0) 0010:Toshiba VF motor (1) 0020:Other (2)	—
581	ቤፎ.ጋ (230/460v units)	0 / 1	00FF	0012 ~ 0078 (90 ~ 600)	5
582	ቤፎ.ጋ (575v units)			001A ~ 00AC (130 ~ 860)	
583	ቤፎ.ፍ	0 / 1	00FF	0000 ~ 00C8 (0 ~ 400)	2
584	ቤፎ.ፍ	0 / 1	FFFF	0000 ~ 270F (0 ~ 9999)	1
585	ቤፎ.ፎገ	0	0008	0000: Auto-tuning disabled (0) 0008: Auto-tuning enabled (1)	—
586	ቤፎ. ዘ	0 / 1	00C0	0000: Small (0) 0040: Medium (1) 0080: Large (2) 00C0: Very large (3)	—

13.4 Drive Typeform Codes

200v Class	
Drive Model	Typeform Data (Hex)
E3-2035	xx24
E3-2055	xx25
E3-2080	xx26
E3-2110	xx27
E3-2160	xx28
E3-2220	xx29
E3-2270	xx2A
E3-2330	xx2B
E3-2400	xx2C
E3-2500	xx2D
E3-2600	xx2E

400v Class	
Drive Model	Typeform Data (Hex)
E3-4055	xx45
E3-4080	xx46
E3-4110	xx47
E3-4160	xx48
E3-4220	xx49
E3-4270	xx4A
E3-4330	xx4B
E3-4400	xx4C
E3-4500	xx4D
E3-4600	xx4E
E3-4750	xx4F
E3-410K	xx50
E3-412K	xx51

600v Class	
Drive Model	Typeform Data (Hex)
E3-6060	xx65
E3-6120	xx67
E3-6160	xx68
E3-6220	xx69
E3-6270	xx6A
E3-6330	xx6B
E3-6400	xx6C
E3-6500	xx6D
E3-6600	xx6E
E3-6750	xx6F
E3-610K	xx70
E3-612K	xx71
E3-615K	xx72
E3-620K	xx73
E3-625K	xx74

Note: Due to the continual capacity expansion of the Toshiba adjustable speed drive family, newly-released drive models may have typeform data which is not documented in this table. If you encounter this situation, or if the LONWORKS interface board is not installed on an E3 ASD, please contact Toshiba International Corporation for verification of your drive model's typeform data.

13.5 Drive Fault Codes

LED Display Message	Data (Hex)	Explanation
nErr	xx00	No error has been recorded since the last drive reset or trip clear
OC1	xx01	Overcurrent during acceleration
OC2	xx02	Overcurrent during deceleration
OC3	xx03	Overcurrent during constant-speed run
OC4	xx04	Load-end overcurrent detected at start-up (output terminals, motor wiring etc.)
OCR1	xx05	U-phase armature short circuit
OCR2	xx06	V-phase armature short circuit
OCR3	xx07	W-phase armature short circuit
EPH1	xx08	Lost input phase (option)
EPH0	xx09	Lost output phase (option)
OP1	xx0A	Overvoltage during acceleration
OP2	xx0B	Overvoltage during deceleration
OP3	xx0C	Overvoltage during constant-speed run
OL1	xx0D	Drive overload
OL2	xx0E	Motor overload
OLr	xx0F	Dynamic braking resistor overload
OH	xx10	Drive overheat
E	xx11	Emergency off
EEP1	xx12	EEPROM failure during write
EEP2	xx13	EEPROM failure during initial read
¾	xx14	Unused
Err2	xx15	RAM error
Err3	xx16	ROM error
Err4	xx17	CPU error
Err5	xx18	RS232C timer time-out
Err6	xx19	Gate array error
Err7	xx1A	Output current detection circuit error
Err8	xx1B	Option PCB error
Err9	xx1C	Option ROM error
UC	xx1D	Low current
UP1	xx1E	Main circuit undervoltage
¾	xx1F	Unused
Ot	xx20	Overtorque
EF1	xx21	Earth fault (software)
EF2	xx22	Earth fault (hardware)
EFU	xx23	Open fuse
OCr	xx24	Dynamic braking resistor overcurrent
OC1P	xx25	Overcurrent in DC section during acceleration
OC2P	xx26	Overcurrent in DC section during deceleration
OC3P	xx27	Overcurrent in DC section during constant-speed run
Et _n	xx28	Auto-tuning error
Et _{YP}	xx29	Drive typeform error
--	xx2A ~ xx50	Unused
ðAMP	xx51	Closed damper detected (E3 only)
LOSS	xx52	Loss of IV input detected (E3 only)

14. LonManager Support Files

Electronic versions of various LonManager, LonMaker[®], and DDE server support files for use with the INV3-LONWORKS interface kit can be downloaded via the internet from <http://www.iccdesigns.com>. Available files include the INV3-LONWORKS External Interface (.XIF) File, LonMaker Visio stencil, and LonMark Device Resource Files (DRFs). These files can be helpful in interfacing the INV3-LONWORKS interface to network installation and configuration tools, custom user interfaces, or computer control and monitoring programs.

15. Notes

TOSHIBA

TOSHIBA INTERNATIONAL CORPORATION

INDUSTRIAL DIVISION

13131 West Little York Rd., Houston, TX 77041

Tel: [800] 231-1412 Fax: [713] 466-8773

World Wide Web <http://www.tic.toshiba.com>

Printed in U.S.A



INDUSTRIAL CONTROL COMMUNICATIONS